

October 16, 2005

Expires in April 2006

**SS7 TCAP-User Adaptation Layer
(TUA)
<draft-bidulock-sigtran-tua-04.ps>**

Status of this Memo

“By submitting this Internet-Draft, each author represents that any applicable patent or other IPR claims of which he or she is aware have been or will be disclosed, and any of which he or she becomes aware will be disclosed, in accordance with Section 6 of BCP 79.”

Internet-Drafts are working documents of the Internet Engineering Task Force (IETF), its areas, and its working groups. Note that other groups may also distribute working documents as Internet-Drafts.

Internet-Drafts are draft documents valid for a maximum of six months and may be updated, replaced, or obsoleted by other documents at any time. It is inappropriate to use Internet-Drafts as reference material or to cite them other than a “work in progress”.

The list of current Internet-Drafts can be accessed at <http://www.ietf.org/ietf/1id-abstracts.txt>.

The list of Internet-Draft Shadow Directories can be accessed at <http://www.ietf.org/shadow.html>.

This Internet-Draft will expire in April 2006.

Copyright

Copyright © The Internet Society (2005).

Abstract

This document defines a protocol for the transport of any SS7 TCAP-User signalling (e.g, INAP, MAP, etc.) over IP using the Stream Control Transport Protocol [RFC 2960]. The protocol should be modular and symmetric, to allow it to work in diverse architectures, such as a Signalling Gateway and IP Signalling End-point architecture. Protocol elements are added to allow seamless operation between peers in the SS7 and IP domains.

Contents

A complete table of contents, list of illustrations and tables, and change history for this document, appears at the end of the document.

1. Introduction

There is on-going integration of SCN and IP networks. Network service providers are designing IP-based signalling architectures that need support for SS7 and SS7-like signalling protocols. IP provides an effective way to transport user data and for operators to expand their networks and build new services. In these networks, there is a need for interworking between the SS7 and IP domains [RFC 2719]. This draft defines a protocol for the transport of SS7 TCAP User protocols [Q.771, T1.114], such as MAP and INAP, over IP using the Stream Control Transmission Protocol (SCTP) [RFC 2960].

1.1. Scope

This document details the delivery of TC-user messages (MAP, CAP, INAP, etc.) over IP between two signalling end-points. Consideration is given for the transport from an SS7 Signalling Gateway (SG) to an IP

signalling node (such as an IP-resident Database) as described in the Framework Architecture for Signalling Transport [RFC 2719] This protocol can also support transport of TC-user messages between two end-points wholly contained within and IP network.

The delivery mechanism addresses the following criteria:

- Support for transfer of TCAP messages
- Support for TCAP operation class 1, 2, 3 and 4 operation.
- Support for the operation of TC-User protocol peers.
- Support for the management of SCTP transport associations between signalling gateways and IP-based signalling nodes.
- Support for distributed IP-based signalling nodes.
- Support for the asynchronous reporting of status changes to management functions.

1.2. Terminology and Abbreviations

1.2.1. Abbreviations

<i>CAP</i>	— CAMEL Application Protocol.
<i>CTP</i>	— Common Transport Protocol.
<i>DNS</i>	— Directory Name Service.
<i>GTT</i>	— Global Title Translation.
<i>HLR</i>	— Home Location Register.
<i>ID</i>	— Identifier.
<i>IMSI</i>	— International Mobile Station Identifier.
<i>INAP</i>	— Intelligent Network Application Part.
<i>IPSP</i>	— IP Signalling Point.
<i>MAP</i>	— Mobile Application Protocol.
<i>MIB</i>	— Management Information Base.
<i>MSC</i>	— Mobile Switching Center.
<i>PC</i>	— SS7 Point Code.
<i>SCCP</i>	— Signalling Connection Control Part.
<i>SCN</i>	— Switched Circuit Network.
<i>SCTP</i>	— Stream Control Transmission Protocol.
<i>SCP</i>	— Signalling Control Point.
<i>SLP</i>	— Service Logic Program.
<i>SS7</i>	— Signalling System No. 7.
<i>SSP</i>	— Service Switching Point.
<i>SUA</i>	— SS7 SCCP-User Adpatation Layer.
<i>TCAP</i>	— Transaction Capabilities Application Part.
<i>TC</i>	— TCAP Component Sub-Layer.
<i>TMF</i>	— Transaction Mapping Function.
<i>TR</i>	— TCAP Transaction Sub-layer.
<i>TUA</i>	— SS7 TCAP-User Adaptation Layer.
<i>VLR</i>	— Visitor Location Register.

1.2.2. Terminology

Application Server (AS) – a logical entity serving a specific Routing Key. An example of an Application Server is a virtual database element handling all HLR or SCP transactions for a particular SS7 Signalling Point. The AS contains a set of one or more unique *Application Server Processes*, of which one or more is normally actively processing traffic. There is a one-to-one relationship between an Application Server and a Routing Key.

Application Server Process (ASP) – a process instance of an Application Server. An *Application Server Process* serves as an active, backup, load-share or broadcast process of an Application Server (e.g. part of a distributed signalling node or database element). Examples of ASPs are MGCs, IP SCs, or IP HLRs. An ASP contains an SCTP end-point and may be configured to process traffic within more than one *Application Server*.

Association – refers to an SCTP association [RFC 2960]. The association provides the transport for the delivery of TCAP protocol data units and TUA layer peer messages.

Component Sub-layer (TC)

The Component Sub-layer of TCAP [Q.771].

Fail-over – the capability to reroute signalling traffic as required to an alternate Application Server Process, or group of ASPs, within an Application Server in the event of failure or unavailability of a currently used Application Server Process. *Fail-over* may apply upon the return to service of a previously unavailable Application Server Process.

Host – the computing platform that the process (SGP, ASP or IPSP) is running on.

IP Server Process (IPSP) – a process instance of an IP-based application. An IPSP is essentially the same as an ASP, except that it uses TUA in a point-to-point fashion.

Layer Management (LM) – a nodal function that handles the inputs and outputs between the TUA layer and a local management entity.

Message Transfer Part (MTP)

The Message Transfer Part [Q.701, T1.111] of the SS7 protocol.

Nodal Interworking Function (NIF) – an implementation dependent interworking function present at a Signalling Gateway that interworks primitives and procedures between the TCAP and TUA layers in the SG.

Network Appearance (NA) – a value that identifies the SS7 network context of a Routing Key. The *Network Appearance* value is of significance only within an administrative domain; it is coordinated between the SG and ASP.

Network Byte Order – the ordering of bytes most-significant-byte first, also referred to as Big Endian.

Routing Context (RC) – a value that uniquely identifies a Routing Key and an Application Server. *Routing Context* values are either configured using a configuration management interface, or by using the Routing Key Management (RKM) messages and procedures defined for TUA.

Routing Key (RK) – describes a set of SS7 parameters and parameter values that uniquely define the range of signalling traffic to be handled by a particular Application Server.

Signalling Connection Control Part (SCCP) – The Signalling Connection Control Part [Q.711] of the SS7 protocol.

Signalling Gateway (SG) – a signalling agent that exchanges SCN native signalling at the edge of the IP network [RFC 2719]. An SG appears to the SS7 network as an SS7 Signalling Point. An SG contains a set of one or more Signalling Gateway Processes, of which one or more is normally actively processing traffic. When an SG contains more than one SGP, the SG is a logical entity and the contained SGPs are assumed to be coordinated into a single management view both toward the SS7 network and toward the supported Application Servers.

Signalling Gateway Process (SGP) – a process instance of a Signalling Gateway. It serves as an active, backup, load-sharing or broadcast process of a Signalling Gateway.

Stream – an SCTP stream; a unidirectional logical channel established from one SCTP endpoint to another associated SCTP endpoint, within which all user messages are delivered in sequence, except for those submitted to the unordered delivery service.

Transaction Capabilities Application Part (TCAP) – The Transaction Capabilities Application Part [Q.771, T1.114] of the SS7 protocol.

Transaction Mapping Function (TMF) – an implementation dependent function that is responsible for resolving the address and application context presented in the incoming TUA message to the correct SCTP association and Routing Context for the desired application. The TMF **MAY** use routing context or routing key information as selection criteria for the appropriate SCTP association.

Transaction Sublayer (TR) – The Transaction Sublayer of TCAP [Q.771].

Transport Address – an address that serves as a source or destination for the unreliable packet transport service used by SCTP. In IP networks, a transport address is defined by the combination of IP address and an SCTP port number [1].

1.3. TUA Overview

1.3.1. Signalling Transport Architecture

The framework architecture that has been defined for SCN signalling transport over IP [RFC 2719] uses multiple components, including an IP transport protocol, a signalling common transport protocol and an adaptation module to support the services expected by a particular SCN signalling protocol from its underlying protocol layer.

In general terms, the TUA architecture can be modeled as a peer-to-peer architecture. The first section considers the SS7-to-IP interworking architectures for TCAP class 1, 2, 3, and 4 operations. For this case, it is assumed that the ASP initiates the establishment of the SCTP association with the SG.

1.3.2. Protocol Architecture for Classes 1, 2, 3 and 4

In this architecture (illustrated in *Figure 1*), the TCAP and TUA layers interface in the SG. A Nodal Interworking Function (NIF) provides for interworking between the TCAP and TUA layers and provides for the transfer of the user messages as well as management messages.

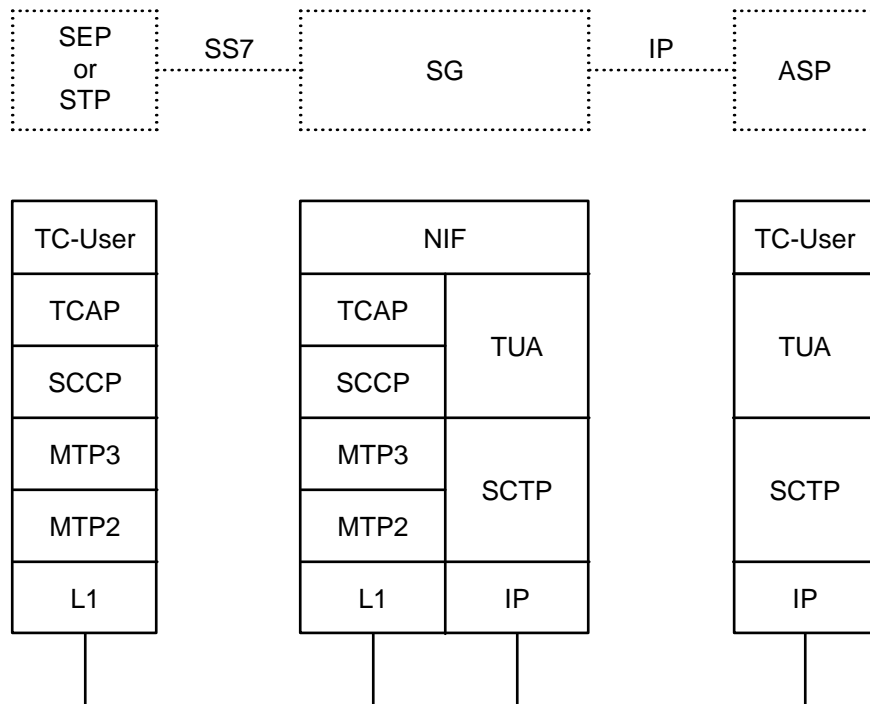

Figure 1. Protocol Architecture

1.3.3. All IP Architecture

This architecture, illustrated in *Figure 2*, can be used to carry a protocol which uses the transport services of TCAP, but is contained within an IP network. This allows extra flexibility in developing networks, especially when interaction between legacy signalling is not needed. The architecture removes the need for a signalling gateway function.

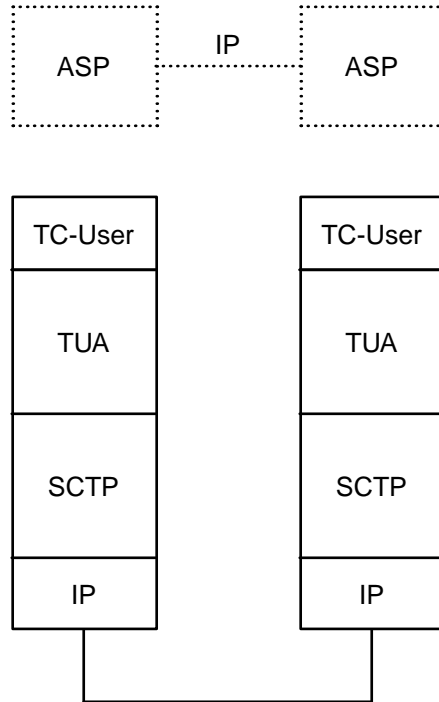

Figure 2. All IP Architecture

1.3.4. ASP Fail-over Model and Terminology

The TUA protocol supports ASP fail-over functions to support a high availability of transaction processing capability.

An Application Server can be considered as a list of all ASPs configured or registered to handled TC-user messages within a certain range of routing information, or within a certain set of transaction dialogues, known as a ‘Routing Key.’ One or more ASPs in the list may normally be active to handle traffic, while others may be inactive but available in the event of failure or unavailability of the active ASPs.

For operational considerations, see Appendix A.

1.3.5. Services Provided by the TUA Layer

1.3.5.1. Support for the transport of TCAP-User Messages

The TUA supports the transfer of TC-user messages. The TUA layer at the SG and the ASP support the seamless transport of user messages between the SG and the ASP.

1.3.5.1.1. TCAP Operation Class Support

Depending on the TC-users supported, the TUA supports the 4 possible TCAP operation classes transparently. The TCAP operation classes are defined as follows:

- Operation Class 1* – provides for transactions reporting both success and failure.
- Operation Class 2* – provides for transactions reporting failure.
- Operation Class 3* – provides for transactions reporting success.
- Operation Class 4* – provides for transactions reporting neither success nor failure.

1.3.5.2. Native Management Functions

The TUA layer provides the capability to indicate errors associated with the TUA-protocol messages and to provide notification to local management and the remote peer as necessary.

1.3.5.3. Interworking with TCAP Management Functions

The TUA layer provides interworking with TCAP management functions at the SG for seamless inter-operation between the SCN network and the IP network. TUA provides the following management functions:

- (1) Provides an indication to the TC-user at an ASP that an SS7 subsystem, SCCP User Part or MTP Destination is unavailable.
- (2) Provides an indication to the TC-user at an ASP that an SS7 subsystem, SCCP User Part or MTP Destination is available.
- (3) Provides an indication to the TC-user at an ASP that an SS7 subsystem or MTP Destination is congested (flow controlled).
- (4) Provides the initiation of an audit of SS7 subsystems or MTP Destinations status at the SG.

Table 1. Mapping of Management Primitives

Name		Reference		TUA Management Message
Generic	Specific	ITU-T Q.711	ANSI T1.112	
N-STATE	Request Indication	6.3.2.3.2	2.3.2.3.2	DUNA DAVA SCON
N-PCSTATE	Indication	6.3.2.3.3	2.3.2.3.4	DUNA DAVA SCON DUPU
N-COORD	Request Indication Response Confirm	6.3.2.3.1	2.3.2.3.3	DRST

The interworking with TCAP management messages consists of DUNA, DAVA, DAUD, DRST, DUPU or SCON messages (defined in *Section 3*) on receipt of management events (defined by TCAP) to the appropriate ASPs. The primitives in *Table 1* are sent between the TCAP and TUA management functions in the SG to trigger events in the IP and SS7 domain.

The TUA layer provides transparent passing of SCCP availability, unavailability and congestion status indication primitives (N-STATE, N-PCSTATE and N-COORD) as provided for in *ITU-T Q.771 2.2.3 [Q.771]*.

1.3.5.4. Support for the Management of SCTP Associations

The TUA layer at the SGP maintains the availability state of all configured remote ASPs, to manage the SCTP Associations and the traffic between TUA peers. As well, the active/inactive and congestion state of

remote ASPs is maintained.

The TUA layer **MAY** be instructed by local management to establish an SCTP association to a peer TUA node. This can be achieved using the M-SCTP_ESTABLISH primitives to request, indicate and confirm the establishment of an SCTP association with a peer TUA node. To avoid redundant SCTP associations between two TUA peers, one side (client) **SHOULD** be designated to establish the SCTP association, or TUA configuration information maintained to detect redundant associations (e.g, via knowledge of the expected local and remote SCTP endpoint addresses).

Local management **MAY** request from the TUA layer the status of the underlying SCTP associations using the M-SCTP_STATUS request and confirm primitives. Also, the TUA **MAY** autonomously inform local management of the reason for the release of an SCTP association, determined either locally within the TUA layer or by a primitive from the SCTP.

Also, the TUA layer **MAY** inform the local management of the change in status of an ASP or AS. This **MAY** be achieved using the M-ASP_STATUS request or M-AS_STATUS request primitives.

1.4. Functional Areas

1.4.1. Dialogue Identifiers, Routing Contexts and Routing Keys

The mapping of TCAP messages into dialogues between the SGP and the Application Servers is determined by Dialogue Identifiers, Routing Keys and their associated Routing Contexts.

A Routing Key is essentially a set of TCAP parameters used to direct TCAP messages; whereas, the Routing Context parameter is a 4-byte value (unsigned integer) that is associated to that Routing Key in a one-to-one relationship. The Routing Context therefore can be viewed as an index into a sending node's Transaction Mapping Function tables containing the Routing Key entries.

Possible TCAP address/routing information that comprise a Routing Key entry includes, for example, a local and remote Point Code, Subsystem Number, Global Title Address, Application Context, local and remote Transaction Id pairs, or TC-User specific information such as User Information, IMSI, SLP. The particular information used to define a TUA Routing Key is application and network dependent, and none of the above examples are requirements for TUA.

An Application Server Process (ASP) may be configured to process signalling traffic related to more than one Application Server (AS), over a single SCTP Association. ASP Active (ASPAC) and ASP Inactive (ASPIA) management messages (see Section 3) use the Routing Context to discriminate signalling traffic to be started or stopped. At an ASP, the Routing Context parameter uniquely identifies the range of signalling traffic associated with each Application Server that the ASP is configured to receive.

1.4.2. Routing Key Limitations

Routing Keys **SHOULD** be unique in the sense that each received TCAP message **SHOULD** have a full or partial match to a single routing result. It is not necessary for the parameter range values within a particular Routing Key to be continuous. For example, an AS could be configured to support transaction processing for multiple ranges of subscribers that are not represented by contiguous Global Title Addresses.

1.4.3. Managing Routing Context and Routing Keys

There are two ways to provision a Routing Key at an SGP. A Routing Key may be configured statically using an implementation dependent management interface, or dynamically managed using the the TUA Routing Key registration procedures.

When using a management interface to configure Routing Keys, the Transaction Mapping Function within the SGP is not limited to the set of parameters defined in this document. Other implementation dependent distribution algorithms may be used.

1.4.4. Transaction Mapping Function

To perform its addressing and relaying capabilities, the TUA makes use of an Transaction Mapping Function (TMF). This function is considered part of TUA, but the way it is realized is left implementation or deployment dependent (local tables, SCCP GTT database, DNS [RFC 2916], LDAP, etc.)

The TMF is invoked when a message is received at the incoming interface. The TMF is responsible for resolving the application context, address and transaction ids presented in the incoming TCAP message to SCTP associations and destinations within the IP network. The TMF will select the key information available. The Routing Keys reference an Application Server, which will normally have one or more ASPs processing transactions for the AS. The availability and status of the ASPs is handled by TUA ASP management messages.

Possible SS7 application context, address or routing information that comprise a Routing Key entry includes, for example, SCCP subsystem number and SCCP addresses and Global Title addresses, Transaction ID, and Application Context.

It is expected that the routing keys will be provisioned via a MIB, dynamic registration or an external process, such as a database.

1.4.4.1. Transaction Mapping at the SG

To direct messages received from the SS7 network to the appropriate IP destination, the SGP must perform a transaction mapping function using information from the received TCAP message.

To support this transaction mapping, the SGP might, for example, maintain the equivalent of a network address translation table, mapping incoming TCAP message information to an Application Server for a particular application and set of transactions. This could be accomplished by comparing the addressing, dialog or component portions of the incoming TCAP message to currently defined Routing Keys in the SGP. These Routing Keys could in turn map directly to an Application Server that is enabled by one or more ASPs. These ASPs proxy dynamic status information regarding their availability, transaction handling capabilities and congestion to the SGP using various management messages defined in the TUA protocol.

The list of ASPs in the AS is assumed to be dynamic, taking into account the availability, transaction handling capability and congestion status of the individual ASPs in the list, as well as configuration changes and possible fail-over mechanisms.

Normally, one or more ASPs are active in the AS (i.e, currently processing transactions) but in certain failure and transition cases it is possible that there may not be an active ASP available. The SGP will buffer the message destined for this AS for a time $T(r)$ or until an ASP becomes available. When no ASP becomes available before expiry of $T(r)$, the SGP will flush the buffered messages and initiate the appropriate TCAP abort procedures.

If there is no transaction mapping function match for an incoming message, a default treatment **MAY** be specified. Possible solutions are to provide a default Application Server to direct all unallocated transactions to a (set of) default ASP(s), or to drop the messages and provide a notification to management. The treatment of unallocated transactions is implementation dependent.

1.4.4.2. Transaction Mapping at the ASP

To direct messages to the SS7 network, the ASP **MAY** perform a transaction mapping to choose the proper SGP for the given message. This is accomplished by observing the Application Context, Destination Address, Destination Transaction Id, and other elements of the outgoing message, SS7 network status, SGP availability, and Routing Context configuration tables.

A Signalling Gateway may be composed of one or more SGPs [2]. There is, however, no TUA messaging to manage the status of an SGP. Whenever an SCTP association to an SGP exists, it is assumed to be available. Also, every SGP of one SG communicating with one ASP regarding one AS provides identical SS7 connectivity to this ASP.

In general, an ASP routes all responses to the SGP that it received messages from; within the routing context which it is currently active and receiving transactions. The ASP uses the routing context to select the SGP.

1.4.5. Signalling Gateway SS7 Layers

The SG is responsible for terminating up to the TC-user of the SS7 protocol, and offering an IP-based extension to its users.

From an SS7 perspective, it is expected that the Signalling Gateway transmits and receives TCAP messages to and from the SS7 Network over standard SS7 network interfaces, using the services of the SCCP [Q.711] and MTP [Q.704] to provide transport of the messages.

Note that it is also possible for the SCCP services to be provided using the services of the SCCP-User Adaptation Layer (SUA) [SUA] and the MTP3-User Adaptation Layer (M3UA) [M3UA].

The TC-SAP through which TUA at the SG obtains its services could reside at a Signalling Transfer Point (STP) or Signalling End Point (SEP) [Q.705].

1.4.6. SS7 and TUA Interworking at the SG

The SGP provides a functional interworking of transport functions between the SS7 network and the IP network by also supporting the TUA adaptation layer. It allows the TCAP application to exchange components in dialogues with an IP-based Application Server Process where the peer TC-User protocol layer exists.

To perform TCAP management, it is required that the TC-User protocols at ASPs receive indications of subsystem availability and congestion, as well as user part availability and signalling point availability and congestion as they would be expected by an SS7 TCAP application. To accomplish this, the N-PCSTATE, N-STATE and N-COORD primitives received at the TCAP upper layer interface at the SG need to be propagated to the remote TC-user lower layer interface at the ASP.

SCCP management messages (such as SSP, SSA) and MTP management messages (such as TFP, TFA) received from the SS7 network **MUST NOT** be encapsulated. The SG **MUST** terminate these messages and generate TUA message as appropriate.

1.4.7. Application Server

A cluster of Application Servers is responsible for providing the overall support for one or more SS7 upper layers. From an TCAP standpoint, an Application Part provides complete support for the upper layer service within a given Application Context. As an example, an Application Part providing HLR capabilities could provide complete support for GSM MAP HLR (and any other, MSC or VLR application parts located at the signalling point) for a given point code.

Where an ASP is connected to more than one SG, the TUA layer must maintain the status of configured SS7 destinations and route messages according to the availability/congestion status of potentially replicated subsystem.

1.4.8. SCTP Stream Mapping

The TUA supports SCTP streams. The SG and AS need to maintain a list of SCTP and TC-Users for mapping purposes. TC-Users requiring sequenced message transfer need to be sent over a stream using sequenced delivery.

TUA **SHOULD NOT** use stream 0 for TUA management messages. It is **OPTIONAL** that sequence delivery be used to preserve the order of management message delivery.

All TUA Dialogue Handling (DH) messages not using the optional component handling interface (i.e, DH messages with components included) **MAY** select unordered delivery, depending on the requirements of the TC-User [3]. All TUA Component Handling (CH) messages and Dialogue Handling (DH) messages with external components **SHOULD** select ordered delivery.

The stream selected is based upon the Sequence Control field in the Quality of Service parameter, the Dialogue Id given by the TC-User over the primitive interface and other traffic information available to the SGP or ASP.

1.4.9. Application Server Redundancy

All TQRY and SSNM messages (e.g, TC-BEGIN, N-STATE) which match a provisioned Routing Key at an SGP are mapped to an Application Server.

The Application Server is the set of all ASPs associated with a specific Routing Key. Each ASP in this set may be active, inactive or unavailable. Active ASPs handle traffic; inactive ASPs might be used when active ASPs become unavailable.

The fail-over model supports an "n+k" redundancy model, where "n" ASPs is the minimum number of redundant ASPs required to handle traffic and "k" ASPs are available to take over for a failed or available ASP. A "1+1" active/backup redundancy is a subset of this model. A simplex "1+0" model is also supported as a subset, with no ASP redundancy.

1.4.10. Flow Control

Local Management at an ASP may wish to stop traffic across an SCTP association to temporarily remove the association from service or to perform testing and maintenance activity. The function could optionally be used to control the start of traffic onto a newly available SCTP association.

1.4.11. Congestion Management

The TUA layer is informed of local and IP network congestion by means of an implementation-dependent function (e.g, an implementation-dependent indication from the SCTP of IP network congestion).

At an ASP or IPSP, the TUA layer indicates congestion to local TC-users by means of an appropriate TCAP primitive (N-PCSTATE, N-STATE, TC-NOTICE), as per current TCAP procedures, to invoke appropriate upper layer responses. When an SG determines that the transport of SS7 messages is encountering congestion, the SG might trigger SS7 Congestion messages to originating SS7 nodes, per the congestion procedures of the relevant SCCP [Q.711, T1.112] or MTP [T1.111, Q.704] standard. (The triggering of SS7 Management messages from an SG is an implementation-dependent function.)

1.5. Definition of TUA Boundaries

TUA has three protocol boundaries: an upper boundary between TUA and the TC-User; a lower boundary between TUA and SCTP; and a layer management boundary between TUA and the Layer Management Function. *Figure 3* illustrates the TUA protocol boundaries.

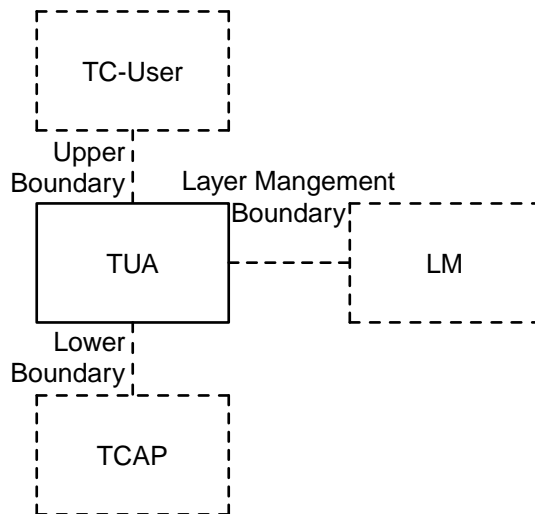

Figure 3. TUA Protocol Boundaries

1.5.1. Definition of Upper Boundary

The primitives and messages listed in *Table 2* are provided between the TUA and TC-User in support of Dialogue Handling [Q.771, T1.114].

Table 2. Mapping of Dialogue Handling Primitives

Generic Name	Specific Name	ITU-T Q.771 Reference	ANSI T1.114 Message	TUA Msg
TC-UNI	Request Indication	3.1.2.2.1	Unidirectional	TUNI
TC-BEGIN	Request Indication	3.1.2.2.2.1	Query w/ Perm	TQRY
-----	-----	-----	Query w/o Perm	
TC-CONTINUE (Initial)	Request Indication	3.1.2.2.2.2	Conv w/ Perm	TCNV
TC-CONTINUE (Non-initial)	Request Indication	3.1.2.2.2.3		
-----	-----	-----		
TC-END	Request Indication	3.1.2.2.2.4	Response	TRSP
TC-U-ABORT	Request Indication		U-Abort	TUAB
TC-P-ABORT	Indication	3.1.4.2	P-Abort	TPAB
TC-NOTICE	Indication	3.1.2.2.3	-----	TNOT

The primitives and messages listed in *Table 3* are provided between the TUA and TC-User in **OPTIONAL** support of Component Handling [Q.771, T1.114].

Table 3. Mapping of Component Handling Primitives

Generic Name	Specific Name	ITU-T Q.771 Reference	ANSI T1.114 Message	TUA Msg
TC-INVOKE	Request Indication	3.1.3.2	Invoke L	CINV
-----	-----	-----	Invoke NL	
TC-RESULT-L TC-RESULT-NL	Request Indication	3.1.3.3	Ret Result L Ret Result NL	CRES
TC-U-ERROR	Request Indication	3.1.3.4	Ret Error	CERR
TC-U-REJECT	Request Indication	3.1.3.5	Reject	CREJ
TC-L-REJECT	Request Indication	3.1.4.1		
TC-R-REJECT	Request Indication			
TC-U-CANCEL TC-L-CANCEL	Request Indication	3.1.3.6	-----	CCAN

1.5.2. Definition of Boundary between TUA and Layer Management

M-SCTP_ESTABLISH request

Direction: LM->TUA

Purpose: LM request ASP to establish an SCTP association with its peer.

M-SCTP_ESTABLISH confirm

Direction: TUA -> LM

Purpose: ASP confirms to LM that it has established an SCTP association with its peer.

M-SCTP_ESTABLISH indication

Direction: TUA -> LM

Purpose: TUA informs LM that a remote ASP has established an SCTP association.

M-SCTP_RELEASE request

Direction: LM -> TUA

Purpose: LM requests ASP to release an SCTP association with its peer.

M-SCTP_RELEASE confirm

Direction: TUA -> LM

Purpose: ASP confirms to LM that it has released SCTP association with its peer.

M-SCTP_RELEASE indication

Direction: TUA -> LM

Purpose: TUA informs LM that a remote ASP has released an SCTP Association or the SCTP association has failed.

M-SCTP RESTART indication

Direction: TUA -> LM

Purpose: TUA informs LM that an SCTP restart indication has been received.

M-SCTP_STATUS request

Direction: LM -> TUA

Purpose: LM requests TUA to report the status of an SCTP association.

M-SCTP_STATUS confirm

Direction: TUA -> LM

Purpose: TUA responds with the status of an SCTP association.

M-SCTP_STATUS indication

Direction: TUA -> LM

Purpose: TUA reports the status of an SCTP association.

M-ASP_STATUS request

Direction: LM -> TUA

Purpose: LM requests TUA to report the status of a local or remote ASP.

M-ASP_STATUS confirm

Direction: TUA -> LM

Purpose: TUA reports status of local or remote ASP.

M-AS_STATUS request

Direction: LM -> TUA

Purpose: LM requests TUA to report the status of an AS.

M-AS_STATUS confirm

Direction: TUA -> LM

Purpose: TUA reports the status of an AS.

M-NOTIFY indication

Direction: TUA -> LM

Purpose: TUA reports that it has received a *Notify (NTFY)* message from its peer.

M-ERROR indication

Direction: TUA -> LM

Purpose: TUA reports that it has received an *Error (ERR)* message from its peer or that a local operation has been unsuccessful.

M-ASP_UP request

Direction: LM -> TUA

Purpose: LM requests ASP to start its operation and send an *ASP Up (ASPUP)* message to its peer.

M-ASP_UP confirm

Direction: TUA -> LM

Purpose: ASP reports that is has received an *ASP UP Ack (ASPUP ACK)* message from its peer.

M-ASP_UP indication

Direction: TUA -> LM

Purpose: TUA reports it has successfully processed an incoming *ASP Up (ASPUP)* message from its peer.

M-ASP_DOWN request

Direction: LM -> TUA

Purpose: LM requests ASP to stop its operation and send an *ASP Down (ASPDN)* message to its peer.

M-ASP_DOWN confirm

Direction: TUA -> LM

Purpose: ASP reports that is has received an *ASP Down Ack (ASPDN ACK)* message from its peer.

M-ASP_DOWN indication

Direction: TUA -> LM

Purpose: TUA reports it has successfully processed an incoming *ASP Down (ASPDN)* message from its peer, or the SCTP association has been lost or reset.

M-ASP_ACTIVE request

Direction: LM -> TUA

Purpose: LM requests ASP to send an *ASP Active (ASPAC)* message to its peer.

M-ASP_ACTIVE confirm

Direction: TUA -> LM

Purpose: ASP reports that is has received an *ASP Active Ack (ASPAC ACK)* message from its peer.

M-ASP_ACTIVE indication

Direction: TUA -> LM

Purpose: TUA reports it has successfully processed an incoming *ASP Active (ASPAC)* message from its peer.

M-ASP_INACTIVE request

Direction: LM -> TUA

Purpose: LM requests ASP to send an *ASP Inactive (ASPIA)* message to its peer.

M-ASP_INACTIVE confirm

Direction: LM -> TUA

Purpose: ASP reports that is has received an *ASP Inactive Ack (ASPIA ACK)* message from its peer.

M-ASP_INACTIVE indication

Direction: TUA -> LM

Purpose: TUA reports it has successfully processed an incoming *ASP Inactive (ASPIA)* message from its peer.

M-AS_ACTIVE indication

Direction: TUA -> LM

Purpose: TUA reports that an AS has moved to the AS-ACTIVE state.

M-AS_INACTIVE indication

Direction: TUA -> LM

Purpose: UA reports that an AS has moved to the AS-INACTIVE state.

M-AS_DOWN indication

Direction: TUA -> LM

Purpose: UA reports that an AS has moved to the AS-DOWN state.

If the TUA layer supports dynamic registration of Routing Key, the layer **MAY** support the following additional primitives:

M-RK_REG request

Direction: LM -> TUA

Purpose: LM requests ASP to register RK(s) with its peer by sending *Registration Request (REG REQ)* message

M-RK_REG confirm

Direction: TUA -> LM

Purpose: ASP reports that it has received *Registration Response (REG RSP)* message with registration status as successful from its peer.

M-RK_REG indication

Direction: TUA -> LM

Purpose: TUA informs LM that it has successfully processed an incoming *Registration Request (REG REQ)* message.

M-RK_DEREG request

Direction: LM -> TUA

Purpose: LM requests ASP to deregister RK(s) with its peer by sending *Deregistration Request (DEREG REQ)* message.

M-RK_DEREG confirm

Direction: TUA -> LM

Purpose: ASP reports that it has received *Deregistration Request (DEREG REQ)* message with deregistration status as successful from its peer.

M-RK_DEREG indication

Direction: TUA -> LM

Purpose: TUA informs LM that it has successfully processed an incoming DEREG REQ from its peer.

1.5.3. Definition of the Lower Boundary

The upper layer primitives provided by the SCTP are provided in the SCTP specification "Stream Control Transmission Protocol (SCTP)" [RFC 2960].

Notes for §1

- [1] **IMPLEMENTATION NOTE:**– Only one SCTP port may be defined for each endpoint, but each SCTP endpoint may have multiple IP addresses [RFC 2960].
- [2] **IMPLEMENTATION NOTE:**– Where more than one route (or SG) is possible for routing to the SS7 network, the ASP could, for example, maintain a dynamic table of available SG routes for the SS7 destinations and subsystems, taking into account the destination and subsystem availability and congestion status received from the SG(s), the availability status of individual SGs and configuration changes or fail-over mechanisms.
- [3] **IMPLEMENTATION NOTE:**– When the TC-User selects sequenced delivery using the "Sequence Control" fields in the Quality of Service parameter, the DH message **SHOULD** be sent on an SCTP stream using ordered delivery. When the TC-User does not select sequenced delivery and does not utilize the optional component handling interface (i.e. the DH message has components included), the DH message **MAY** be sent on an SCTP stream using unordered delivery.

2. Conventions

The keywords “**MUST**”, “**MUST NOT**”, “**REQUIRED**”, “**SHALL**”, “**SHALL NOT**”, “**SHOULD**”, “**SHOULD NOT**”, “**RECOMMENDED**”, “**NOT RECOMMENDED**”, “**MAY**”, and “**OPTIONAL**”, when they appear in this document, are to be interpreted as described in [RFC 2119].

In this document, the following conventions are used to describe how a parameter is used in the message:

- Mandatory* The parameter **MUST** be present in the message. A message listing a parameter as *Mandatory* without containing such a parameter is incorrectly formatted.
- Conditional* The parameter **SHOULD** be present in the message under the conditions specified. A message listing a parameter as *Conditional* without containing such a parameter under the conditions specified is incorrectly formatted.
- Optional* The parameter **MAY** be present in the message as specified. A message listing a parameter as *Optional* without containing such a parameter is correctly formatted.

3. Protocol Elements

The general message format includes a Common Message Header together with a list of zero or more parameters as defined by the Message Type.

For forward compatibility, all Message Types **MAY** have attached parameters even if none are specified in this version.

3.1. Common Message Header

The protocol messages for the TCAP-User Adaptation Protocol (TUA) require a message structure that contains a version, message type, message length and message contents:

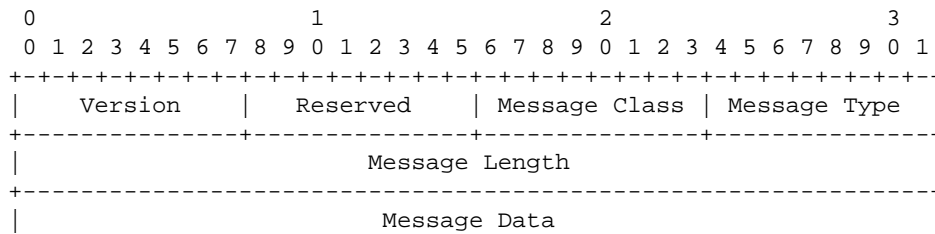

Notes:

- This message header is common among all signalling protocol adaptation layers.
- The 'data' portion of TUA messages **SHALL** contain zero or more TUA parameters, and **SHALL NOT** contain an encapsulated TCAP message.
- Optional parameters can only occur at most once in a TUA message.
- All fields in the TUA message **MUST** be transmitted in the network byte order, unless otherwise stated.
- The *Reserved* field is set to 0 in messages sent and is not examined in messages received.

3.1.1. TUA Protocol Version

Version: 8-bits (unsigned integer)

The *Version* field of the Common Message Header contains the version of the TUA adaptation layer. The supported versions are:

- 1 – TUA Version 1.0

3.1.2. Message Classes

Message Class: 8-bits (unsigned integer)

The *Message Class* field of the Common Message Header contains the class of the message. The supported classes are as follows:

- 0 Management (MGMT) Message
- 7 Reserved for Other Signalling Adaptation Layers
- 2 SS7 Signalling Network Management (SSNM) Messages
- 3 ASP State Maintenance (ASPSM) Messages
- 4 ASP Traffic Maintenance (ASPTM) Messages
- 5 TUA Dialogue Handling (DH) Messages
- 6 TUA Component Handling (CH) Messages
- 7 Reserved for Other Signalling Adaptation Layers
- 8 Reserved for Other Signalling Adaptation Layers
- 9 Routing key Management (RKM) Messages
- 10 - 127 Reserved by the IETF
- 128 - 255 Reserved for IETF-Defined Message Class Extensions

3.1.3. Message Types

Message Type: 8-bits (unsigned integer)

The *Message Type* field of the Common Message Header contains the type of message within a message class. The supported types of messages within the supported classes are as follows:

Management (MGMT) Messages

- 0 Error (ERR)
- 1 Notify (NTFY)
- 2 - 127 Reserved by the IETF
- 128 - 255 Reserved for IETF-Defined Message Class Extensions

SS7 Signalling Network Management (SSNM) Messages

- 0 Reserved
- 1 Destination Unavailable (DUNA)
- 2 Destination Available (DAVA)
- 3 Destination State Audit (DAUD)
- 4 Destination Congestion (SCON)
- 5 Destination User Part Unavailable (DUPU)
- 6 Destination Restricted (DRST)
- 7 - 127 Reserved by the IETF
- 128 - 255 Reserved for IETF-Defined Message Class Extensions

Application Server Process State Maintenance (ASPSM) Messages

- 0 Reserved
- 1 ASP Up (UP)
- 2 ASP Down (DOWN)
- 3 Heartbeat (BEAT)
- 4 ASP Up Ack (UP ACK)
- 5 ASP Down Ack (DOWN ACK)
- 6 Heartbeat Ack (BEAT ACK)
- 7 - 127 Reserved by the IETF
- 128 - 255 Reserved for IETF-Defined Message Class Extensions

Application Server Process Traffic Maintenance (ASPTM) Messages

- 0 Reserved
- 1 ASP Active (ASPAC)
- 2 ASP Inactive (ASPIA)
- 3 ASP Active Ack (ASPAC ACK)
- 4 ASP Inactive Ack (ASPIA ACK)
- 5 - 127 Reserved by the IETF
- 128 - 255 Reserved for IETF-Defined Message Class Extensions

Routing Key Management (RKM) Messages

- 0 Reserved
- 1 Registration Request (REG REQ)
- 2 Registration Response (REG RSP)
- 3 Deregistration Request (DEREG REQ)
- 4 Deregistration Response (DEREG RSP)
- 5 - 127 Reserved by the IETF
- 128 - 255 Reserved for IETF-Defined Message Class Extensions

TUA Dialogue Handling (DH) Messages

- 0 Unidirectional(TUNI)
- 1 Query (TQRY)
- 2 Conversation (TCNV)
- 3 Response (TRSP)
- 4 U-Abort (TUAB)
- 5 P-Abort (TPAB)
- 6 Notice (TNOT)
- 7 - 127 Reserved by the IETF
- 128 - 255 Reserved for IETF-Defined Message Class Extensions

TUA Component Handling (CH) Messages

- 1 Invoke (CINV)
- 2 Result (CRES)
- 3 Error (CERR)
- 4 Reject (CREJ)
- 5 Cancel (CCAN)
- 6 - 127 Reserved by the IETF
- 128 - 255 Reserved for IETF-Defined Message Class Extensions

3.1.4. Message Length

Message Length: 32-bits (unsigned integer)

The *Message Length* field of the Common Message Header defines the length of the message in octets, including the header.

3.1.5. Tag-Length-Value Format

TUA messages consist of a Common Message Header followed by zero or more parameters, as defined by the message type. The Tag-Length-Value (TLV) parameters contained in a message are defined in a Tag-Length-Value format as shown below [1].

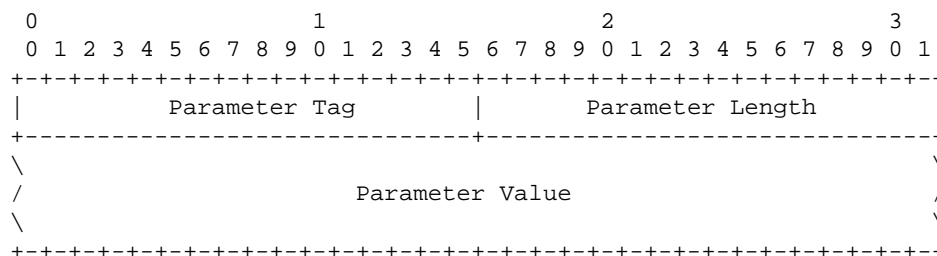

Parameter Tag: 16-bits (unsigned integer)

The Parameter Tag field is a 16-bit identifier of the type of parameter. It takes a value of 0 to 65534.

Parameter Length: 16-bits (unsigned integer)

The Parameter Length field contains the size of the parameter in bytes, including the Parameter Tag, Parameter Length, and Parameter Value fields. The Parameter Length does not include any padding bytes. However, composite parameters will contain all padding bytes, since all parameters contained within this composite parameter will be considered multiples of 4 bytes.

Parameter Value: variable-length

The Parameter Value field contains the actual information to be transferred in the parameter. The total length of a parameter (including Tag, Parameter Length and Value fields) **MUST** be a multiple of 4 bytes. If the length of the parameter is not a multiple of 4 bytes, the sender **MUST** pad the Parameter at the end (i.e., after the Parameter Value field) with all zero bytes. The length of the padding **MUST NOT** be included in the parameter length field. A sender **SHOULD NOT** pad with more than 3 bytes. The receiver **MUST** ignore the padding bytes.

3.2. TUA Message Header

In addition to the Common Message Header, a specific message header is included for TUA messages. The TUA message header will immediately follow the Common Message Header in TUA Dialogue Handling (DH) and Component Handling (CH) messages.

The *TUA Message Header* is formatted as follows:

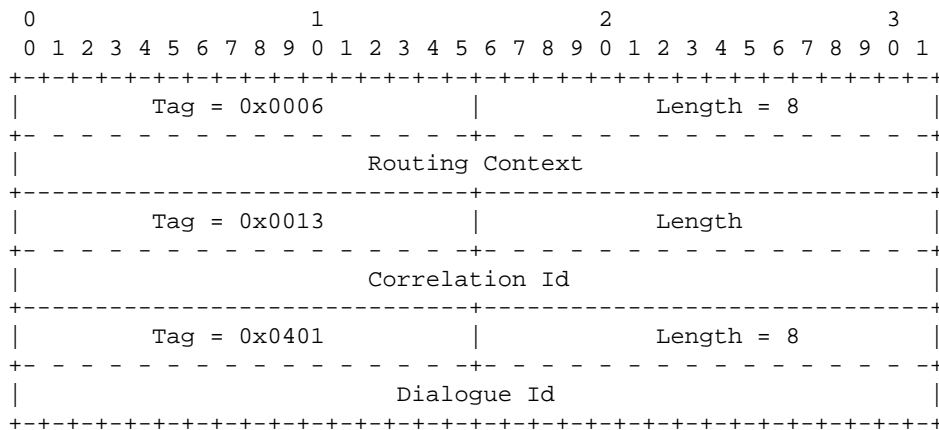

The TUA Message header can contain the following parameters:

Parameters

<i>Routing Context</i>	Conditional	*1
<i>Correlation Id</i>	Conditional	*2
<i>Dialogue Id</i>	Conditional	*3

Note 1: When an ASP is registered or configured for multiple AS with an SG, the Routing Context **MUST** be present in the TUA Message Header. The Routing Context **SHOULD** always be placed in the TUA Message Header. When the Routing Context is present in the TUA Message Header it **SHOULD** be placed first in the header because the context of the Dialogue Id depends on the Routing Context.

Note 2: Under some circumstances, the Correlation Id parameter **MUST** be included in the TUA Message Header. See sections "Correlation Id" and "ASP Active Procedures".

Note 3: When an AS is handling multiple Dialogues, the Dialogue Id parameter **MUST** be placed in the TUA Message Header. The Dialogue Id parameter **SHOULD** always be placed in the TUA Message Header. The Dialogue Id parameter **MAY** be excluded from the TUA header for *TUNI* and *TPAB* DH messages, or may be included but then **MUST** contain a value of zero.

3.3. TUA Dialogue Handling (DH) Messages

The following section describes the TUA Dialogue Handling (DH) messages and parameter contents. The general message format includes a Common Message Header, the TUA Message Header and the DH Message Header, together with a list of zero or more parameters as defined by the Message Type. For forward compatibility, all Message Types **MAY** have optional attached parameters in addition to the message headers.

3.3.1. DH Message Header

In addition to the Common Message Header and TUA Message Header, a specific message header is included for TUA Dialogue Handling (DH) messages. The DH Message Header will immediately follow the TUA Message header in these messages.

The *DH Message Header* is formatted as follows:

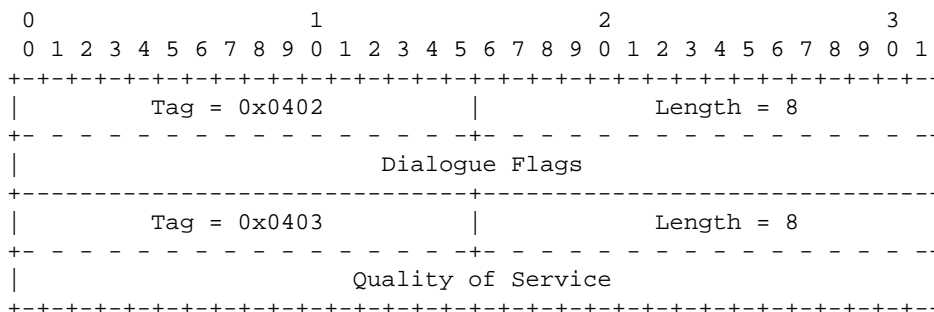

The *DH Message header* contains the following parameters:

Parameters	
<i>Dialogue Flags</i>	Mandatory
<i>Quality of Service</i>	Mandatory

3.3.2. Unidirectional (TUNI)

The *Unidirectional (TUNI)* Request message is sent from an ASP to an SG or IPSP to invoke a TCAP class 4 operation. The *TUNI* Indication message is sent from an SGP to an ASP to indicate the TCAP class 4 operation.

The *TUNI* message corresponds to the ITU-T ‘TC-UNI’ primitive [Q.771], and the ITU-T and ANSI ‘Unidirectional’ message [T1.114, Q.773].

The *TUNI* message is formatted as follows:

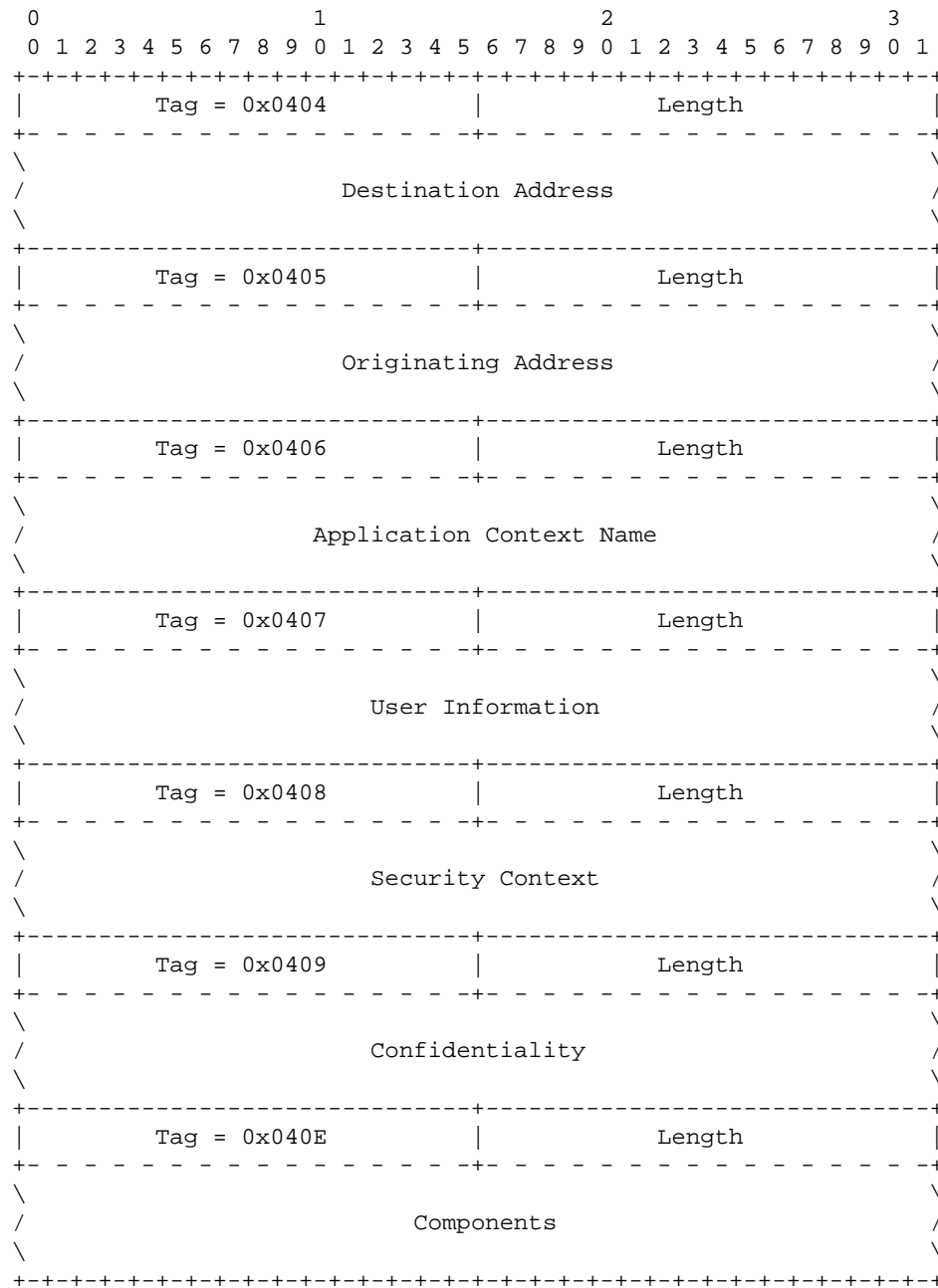

The *TUNI* message can contain the following parameters:

Parameters

<i>Destination Address</i>	Conditional	*1
<i>Originating Address</i>	Conditional	*1
<i>Application Context Name</i>	Optional	
<i>User Information</i>	Optional	
<i>Security Context</i>	Optional	
<i>Confidentiality</i>	Optional	
<i>Components</i>	Optional	*2

Note 1: The *Destination Address* or *Originating Address* parameter **MUST** be present in the *TUNI* message when either parameter is not implied by the Routing Context in the TUA Message Header.

Note 2: Any components **SHOULD** be included in the *TUNI* messages but **MAY** be formatted in separate TUA Component Handling (CH) messages.

3.3.3. Query (TQRY)

The *Query* (*TQRY*) message is sent to a TUA peer to begin a new dialogue between TC-Users.

The *TQRY* message corresponds to the ITU-T 'TC-BEGIN' primitive [Q.771], the ITU-T 'Begin' message [Q.773] and the ANSI 'Query' message [T1.114].

The *TQRY* message is formatted as follows:

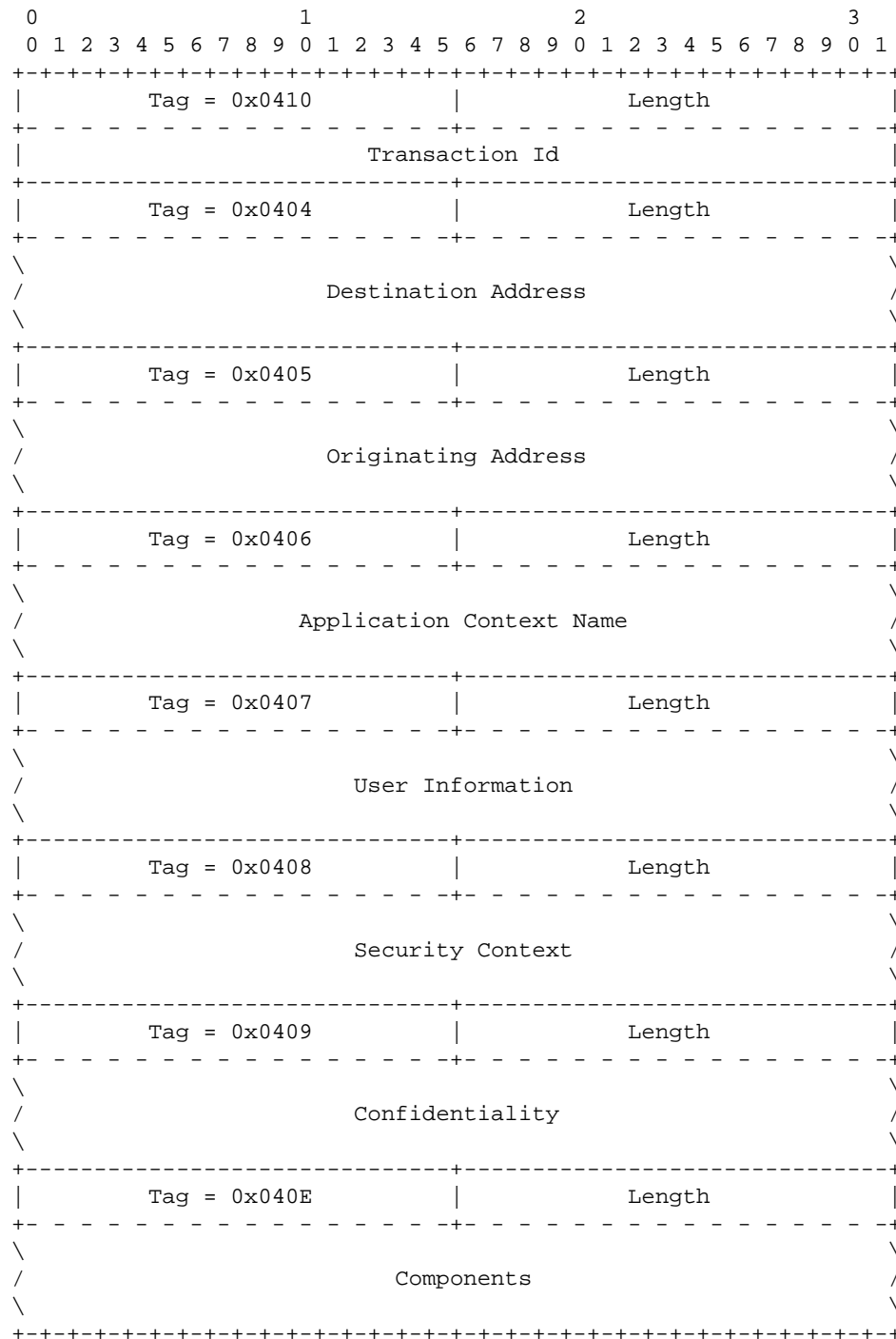

The *TQRY* message can contain the following parameters:

Parameters

<i>Transaction Id</i>	Mandatory
<i>Destination Address</i>	Conditional *1
<i>Originating Address</i>	Conditional *1
<i>Application Context Name</i>	Optional
<i>User Information</i>	Optional

<i>Security Context</i>	Optional	
<i>Confidentiality</i>	Optional	
<i>Components</i>	Optional	*2

Note 1: The *Destination Address* or *Originating Address* parameter **MUST** be present in the *TQRY* message when the parameter is not implied by the Routing Context in the TUA Message Header.

Note 2: Any components **SHOULD** be included in the *TQRY* messages but **MAY** be formatted in separate Component Handling (CH) messages.

3.3.4. Conversation (TCNV)

The *Conversation (TCNV)* message is used in response to a *TQRY* message or another *TCNV* message.

When sent in response to a *TQRY* message, the *TCNV* message confirms and continues a dialogue; when in response to a received *TCNV* message, it only continues a dialogue. The Dialogue Flags in the DH Message Header indicate whether the initiator of the *TCNV* message give permission to the peer to terminate the dialogue.

The *TCNV* message corresponds to the ITU-T 'TC-CONTINUE' primitive [Q.771], ITU-T 'Continue' message [Q.773] and the ANSI 'Conversation' message [T1.114].

The *TCNV* message is formatted as follows:

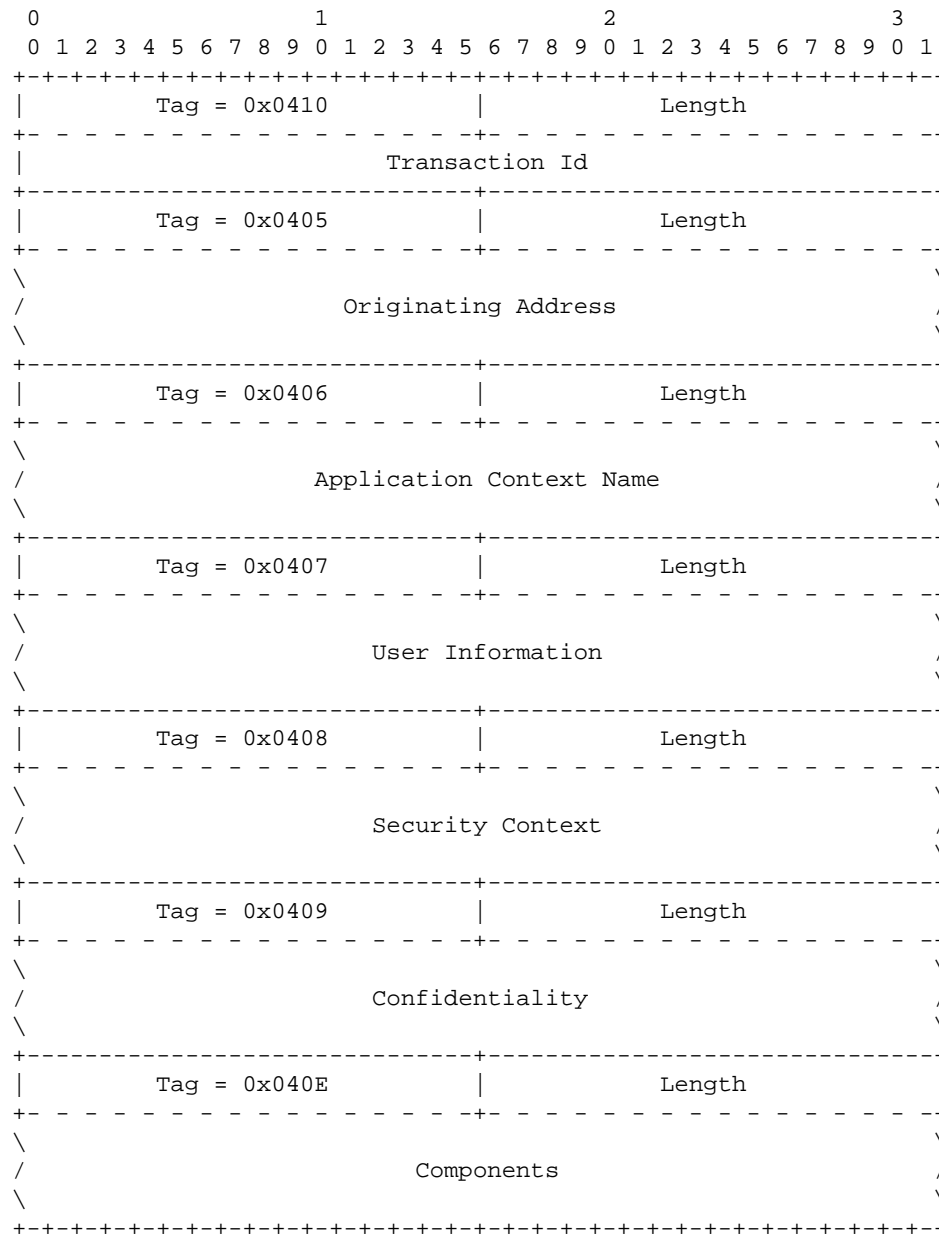

The *TCNV* message can contain the following parameters:

Parameters

<i>Transaction Id</i>	Conditional	*1
<i>Originating Address</i>	Conditional	*2
<i>Application Context Name</i>	Conditional	*3
<i>User Information</i>	Conditional	*3
<i>Security Context</i>	Conditional	*3
<i>Confidentiality</i>	Conditional	*3
<i>Components</i>	Optional	*4

Note 1: The *Transaction Id* parameter **MUST** be present in the **TCNV** message when the message is sent in response to a **TQUR** message. The *Transaction Id* parameter contains the Transaction Identifier assigned by the remote TC-User.

- Note 2: The *Originating Address parameter* **MUST** be present in the *TCNV* message when the message is used in response to a *TQRY* message and the parameter is not implied by the Routing Context in the TUA Message Header.
- Note 3: These dialogue portion parameters **SHOULD** only be optionally included in the *TCNV* message when the message is used in response to a *TQRY* message. When the *TCNV* message is sent in response to a received *TCNV* message, these parameters **SHOULD NOT** be included in the responding *TCNV* message.
- Note 4: Any components **SHOULD** be included in the *TCNV* messages but **MAY** be formatted in separate Component Handling (CH) messages.

3.3.5. Response (TRSP)

The *Response (TRSP)* message is used in response to a *TQRY* message or *TCNV* message to complete and existing dialogue.

When sent in response to a *TQRY* message, the *TRSP* message confirms and completes a dialogue; when in response to a received *TCNV* message, it only terminates a dialogue.

The *TRSP* message corresponds to the ITU-T 'TC-END' primitive [Q.771], ITU-T 'End' message [Q.773] and the ANSI 'Response' message [T1.114].

The *TRSP* message is formatted as follows:

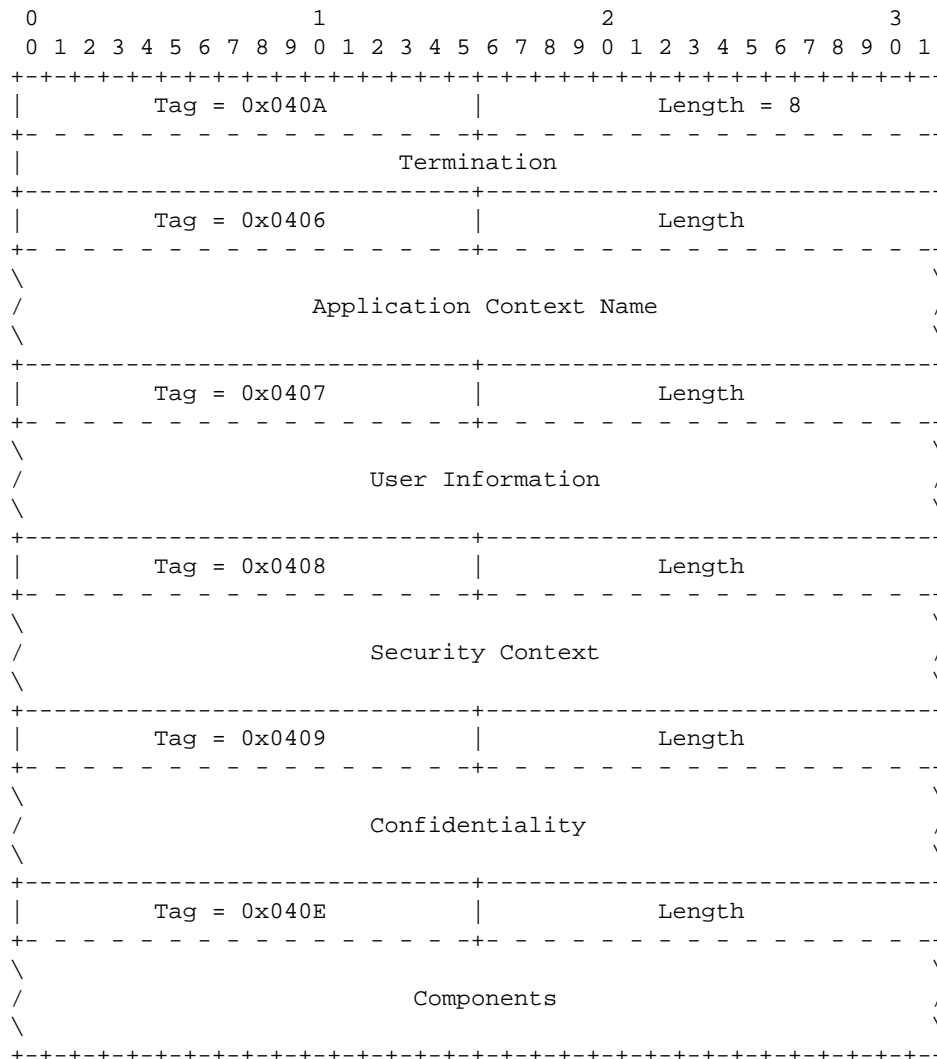

The *TRSP* message can contain the following parameters:

Parameters

<i>Termination</i>	Mandatory	
<i>Application Context Name</i>	Optional	*1
<i>User Information</i>	Optional	*1
<i>Security Context</i>	Optional	*1
<i>Confidentiality</i>	Optional	*1
<i>Components</i>	Optional	*2

Note 1: These dialogue portion parameters **SHOULD** only be optionally included in the *TRSP* message when it is issued in response to an *TQRY* message. When the *TRSP* message is in response to a *TCNV* message, the dialogue portion parameters **SHOULD NOT** be included in the *TRSP* message.

Note 2: Any components **SHOULD** be included in the *TRSP* messages but **MAY** be formatted in separate TUA Component Handling (CH) messages.

3.3.6. U-Abort (TUAB)

The TUA peer sends an *U-Abort (TUAB)* message when it wishes to abort a dialogue, either under TUA-user control (TC-U-ABORT).

When sent in response to a *TQRY* message, the *TUAB* message negatively confirms and aborts a dialogue; when in response to a received *TCNV* message, it only aborts a dialogue.

The *TUAB* message corresponds to the ITU-T ‘TC-U-ABORT’ primitive [Q.771], the ITU-T ‘Abort’ message [Q.773] and the ANSI ‘Abort’ message [T1.114].

The *TUAB* message is formatted as follows:

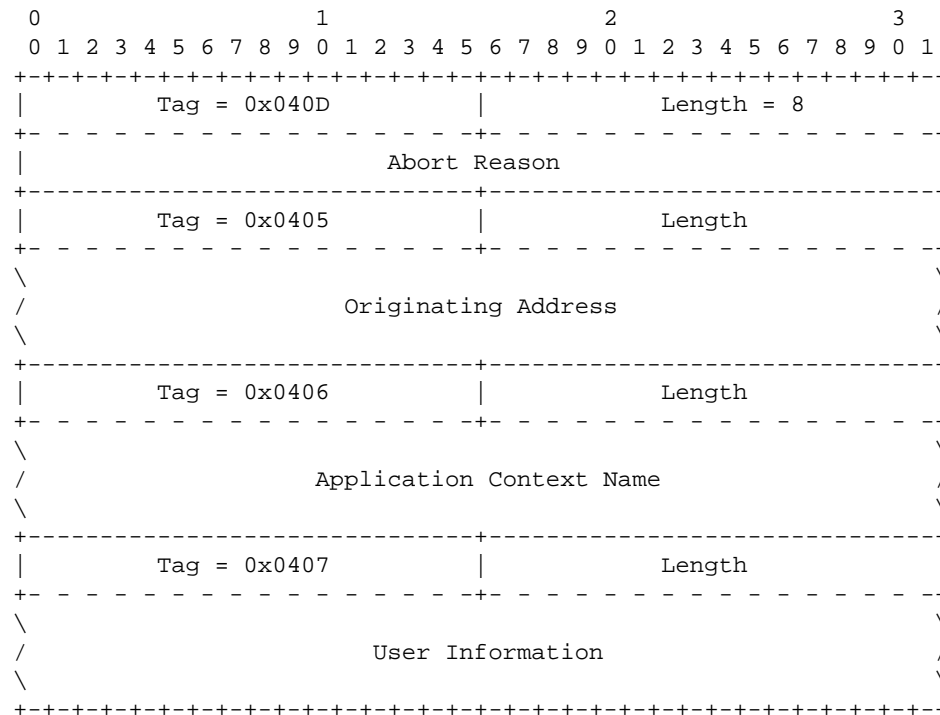

The *TUAB* message can contain the following parameters:

Parameters		
<i>Abort Reason</i>		Mandatory
<i>Application Context Name</i>		Conditional *1
<i>User Information</i>		Optional *2

Note 1: These dialogue portion parameters **SHOULD** only be optionally included in the *TUAB* message when it is issued in response to an *TQRY* message. When the *TUAB* message is in response to a *TCNV* message, the dialogue portion parameters **SHOULD NOT** be included in the *TUAB* message.

Note 2: The User Information parameter carries any User Abort Information.

3.3.7. P-Abort (TPAB)

The TUA peer sends an *P-Abort (TPAB)* message when it wishes to abort a dialogue, either under TUA control (TC-P-ABORT).

The *TPAB* message corresponds to the ITU-T ‘TC-P-ABORT’ primitive [Q.771], the ITU-T ‘Abort’ message [Q.773] and the ANSI ‘Abort’ message [T1.114].

The *TPAB* message is formatted as follows:

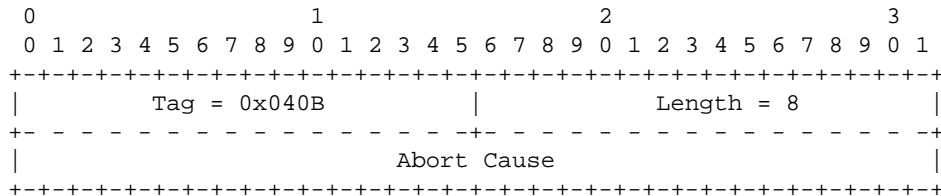

The *TPAB* message can contain the following parameters:

Parameters	
<i>Abort Cause</i>	Mandatory

3.3.8. Notice (TNOT)

An SG sends a *Notice (TNOT)* message when it wishes to inform the ASP of a network condition that concerns the transmission of TCAP or TUA messages to the remote TC-User in a dialogue [Q.775]. It is used at the SG when an SCCP message containing TC-User information from an AS has been returned in a UDTS when the "Return Option" flag was set in the Quality of Service parameters when the message was sent.

The *TNOT* message corresponds to the ITU-T [Q.771] TC-NOTICE primitive.

The *TNOT* message is formatted as follows:

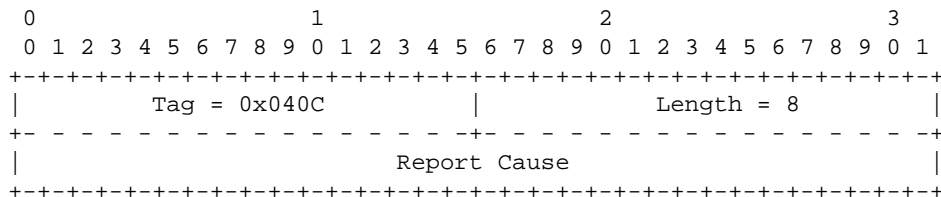

The *TNOT* message can contain the following parameters:

Parameters	
<i>Report cause</i>	Mandatory

3.4. TUA Component Handling (CH) Messages

The following section describes the TUA Component Handling messages and parameter contents. The general message format includes a Common Message Header, a TUA Message Header, a CH Message Header, followed by a list of zero or more parameters as defined by the Message Type. For forward compatibility, all Message Types **MAY** have attached optional parameters in addition to the message headers.

Component Handling (CH) messages are used to convey components associated with operations within a dialogue. They are issued prior to the Dialogue Handling (DH) message with which they are associated, but are received after receiving a Dialogue Handling (DH) message that has the "Components Present" bit set in the Dialogue Flags parameter within the DH message.

3.4.1. CH Message Header

In addition to the Common Message Header and TUA Message Header, a specific message header is included for TUA Component Handling (CH) messages. The CH Message Header will immediately follow the TUA Message Header in these messages.

The *CH Message Header* is formatted as follows:

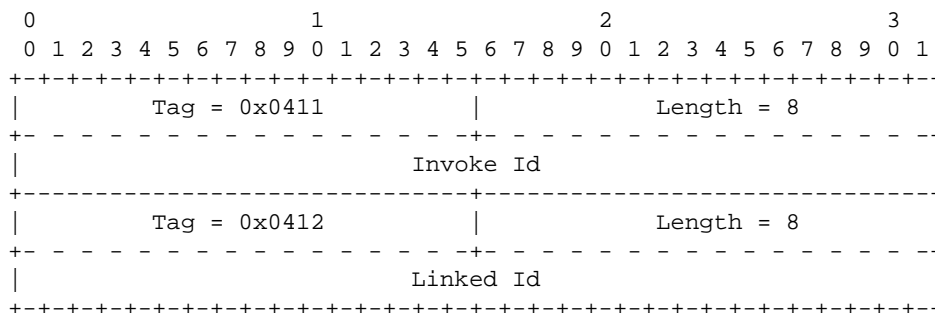

The *CH Message Header* can contain the following parameters:

Parameters	
<i>Invoke Id</i>	Mandatory
<i>Linked Id</i>	Optional

3.4.2. Invoke (CINV)

The *Invoke (CINV)* message is used to invoke an operation within a dialogue.

The *CINV* message corresponds to the ITU-T ‘TC-INVOKE’ primitive [Q.771], the ITU-T ‘Invoke’ component [Q.773], and the ANSI ‘Invoke (Last)’ and ‘Invoke (Not Last)’ components [T1.114].

The *CINV* message is formatted as follows:

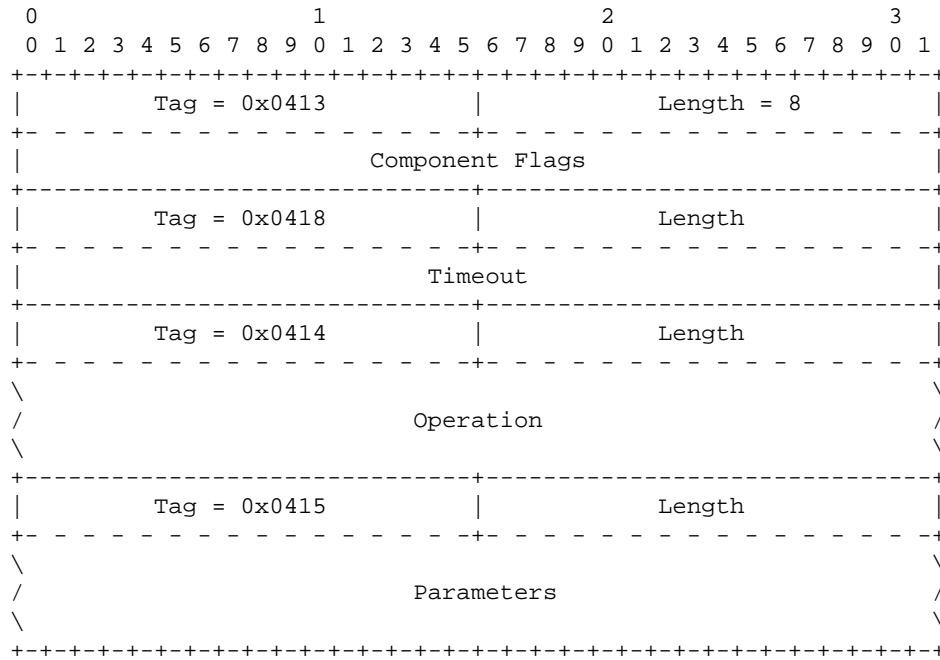

The *CINV* message can contain the following parameters:

Parameters

<i>Component Flags</i>	Mandatory	*1
<i>Timeout</i>	Mandatory	
<i>Operation</i>	Mandatory	
<i>Parameters</i>	Optional	

Note 1: The Component Flags parameter **MAY** be ignored by the receiver of the *CINV* message for ITU-T protocol variants of TC-Users that do not support the concept of a "Not Last" TC-INVOKE primitive.

3.4.3. Result (CRES)

The *Result (CRES)* message is used to report the successful completion of an operation within a dialogue.

The *CRES* message corresponds to the ITU-T ‘TC-RESULT-L’ and ‘TC-RESULT-NL’ primitives [Q.771], the ITU-T ‘Return Result (Last)’ and ‘Return Result (Not Last)’ components [Q.773] and the ANSI ‘Return Result (Last)’ and ‘Return Result (Not Last)’ components.

The *CRES* message is formatted as follows:

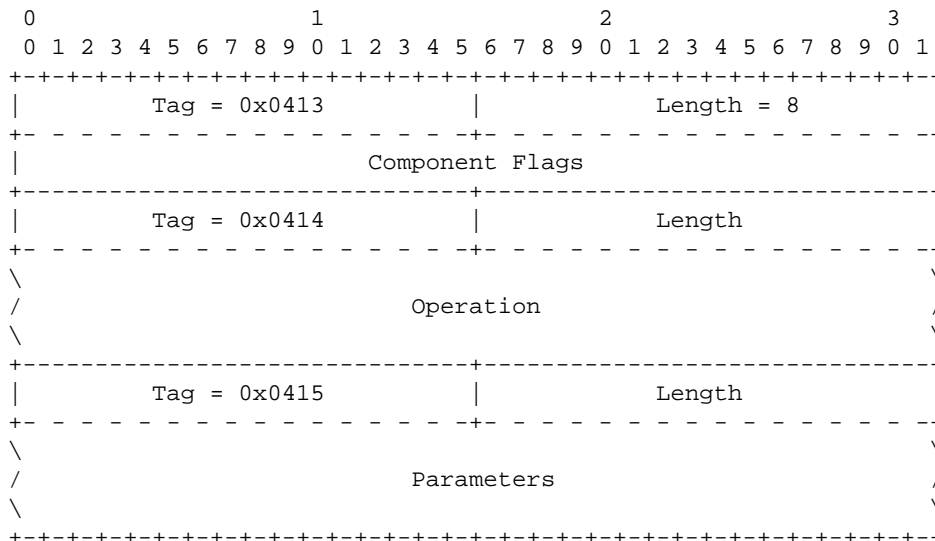

The *CRES* message can contain the following parameters:

Parameters

<i>Component Flags</i>	Mandatory
<i>Operation</i>	Conditional *1
<i>Parameters</i>	Optional

Note 1: The *Operation* parameter **MUST** be present in the **CRES** message when the *Parameters* parameter is also present.

3.4.4. Error (CERR)

The *Error (CERR)* message is used to report the failure of an operation within a dialogue.

The *CERR* message corresponds to the ITU-T ‘TC-U-ERROR’ primitive [Q.771], the ITU-T ‘Return Error’ component [Q.773] and the ANSI ‘Return Error’ component [T1.114].

The *CERR* message is formatted as follows:

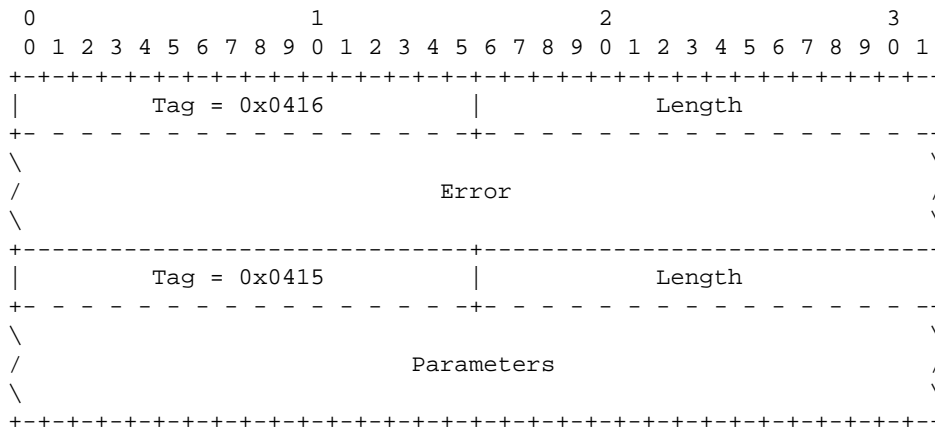

The *CERR* message can contain the following parameters:

Parameters		
<i>Error</i>	Mandatory	
<i>Parameters</i>	Conditional	*1

Note 1: The *Parameters* parameter is only included in the message for specific error codes.

3.4.5. Reject (CREJ)

The *Reject (CREJ)* message is used to reject an operation within a dialogue.

The *CREJ* message corresponds to the ITU-T ‘TC-L-REJECT’, ‘TC-R-REJECT’ and ‘TC-U-REJECT’ primitives [Q.771], the ITU-T ‘Reject’ component [Q.773] and the ANSI ‘Reject’ component [T1.114].

The *CREJ* message is formatted as follows:

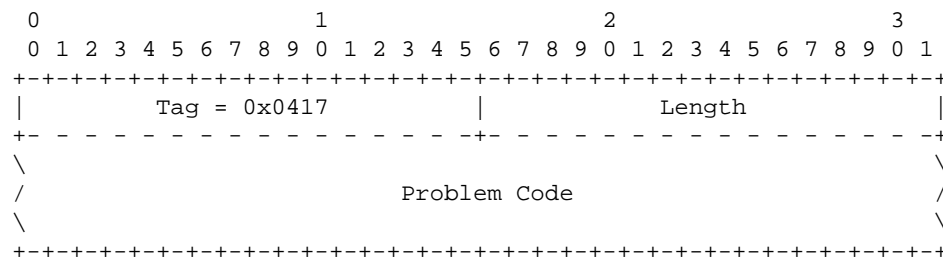

The *CREJ* message can contain the following parameters:

Parameters	
<i>Problem Code</i>	Mandatory

3.4.6. Cancel (CCAN)

The *Cancel (CCAN)* message is used to cancel an operation within a dialogue.

The *CCAN* message corresponds to the ITU-T ‘TC-L-CANCEL’ and ‘TC-U-CANCEL’ primitives [Q.771].

The *CCAN* message presently contains no Message-Type-specific parameters.

3.5. SS7 Signalling Network Management (SSNM) Messages

SS7 Signalling Network Management (SSNM) Messages are used to convey network management information to the TC-User. These messages correspond to specific N-STATE, N-PCSTATE and N-COORD primitives.

3.5.1. Destination Unavailable (DUNA)

The **Destination Unavailable (DUNA)** message is sent from an SGP to all concerned ASPs to indicate the unavailability of an SS7 SCCP subsystem or signalling point. The TC-User at the ASP is expected to stop traffic to TC-User peers at the affected subsystems or signalling points via the SG initiating the **DUNA** message.

When the **DUNA** message contains the *Subsystem Number* parameter, the message corresponds to the ITU-T [Q.711] and ANSI [T1.112] ‘N-STATE’ primitive. When the **DUNA** message does not contain the *Subsystem Number* parameter, message, the message corresponds to the ITU-T [Q.711] and ANSI [T1.112] ‘N-PCSTATE’ primitive.

The *DUNA* message is formatted as follows:

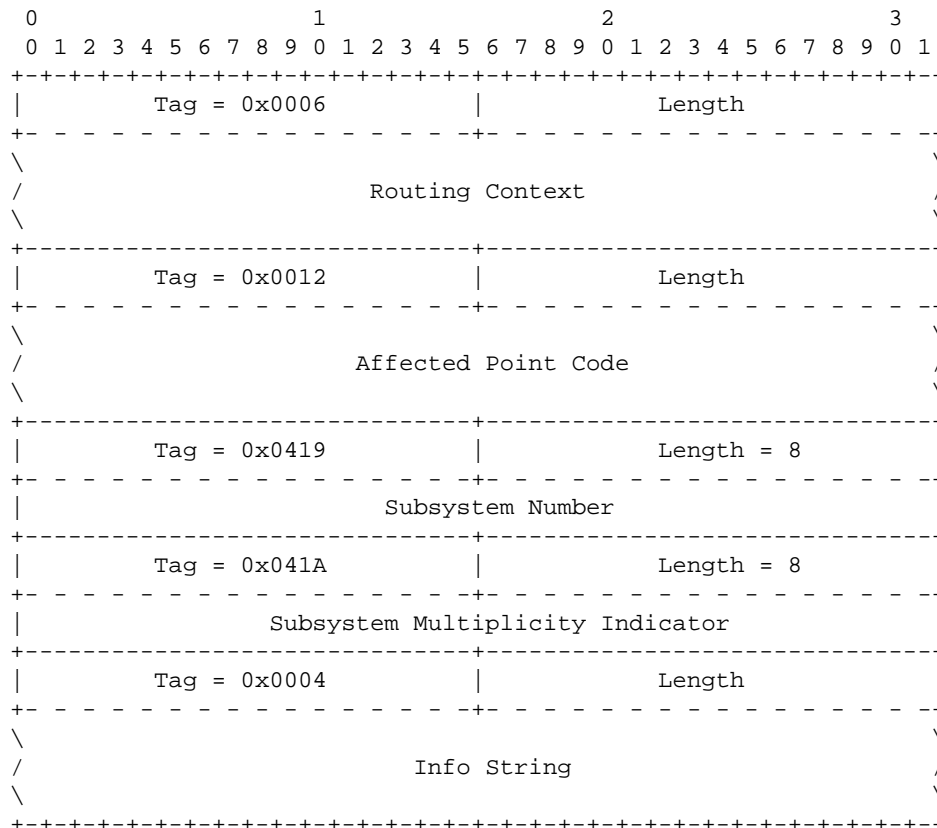

The *DUNA* message can contain the following parameters:

Parameters

<i>Routing Context</i>	Mandatory
<i>Affected Point Code</i>	Mandatory
<i>Subsystem Number</i>	Conditional *1
<i>Subsystem Multiplicity Indicator</i>	Optional *2
<i>Info String</i>	Optional

Note 1: The *Subsystem Number* parameter **SHALL** be present in the **DUNA** message when indicating the unavailability of a subsystem, and **SHALL NOT** be present when indicating the unavailability of a signalling point.

Note 2: The *Subsystem Multiplicity Indicator* parameter **SHOULD NOT** be present in the **DUNA** message when the *Subsystem Number* parameter is not also present.

3.5.2. Destination Available (DAVA)

The **Destination Available (DAVA)** message is sent from an SGP to all concerned ASPs to indicate the availability of an SS7 SCCP Subsystem or signalling point. The TC-User at the ASP is expected to resume traffic to TC-Users peers at the affected subsystems or signalling points via the SG initiating the **DAVA** message.

When the **DAVA** message contains the *Subsystem Number* parameter, the message corresponds to the ITU-T [Q.711] and ANSI [T1.112] 'N-STATE' primitive. When the **DAVA** message does not contain the *Subsystem Number* parameter, message, the message corresponds to the ITU-T [Q.711] and ANSI [T1.112] 'N-PCSTATE' primitive.

The *DAVA* message is formatted as follows:

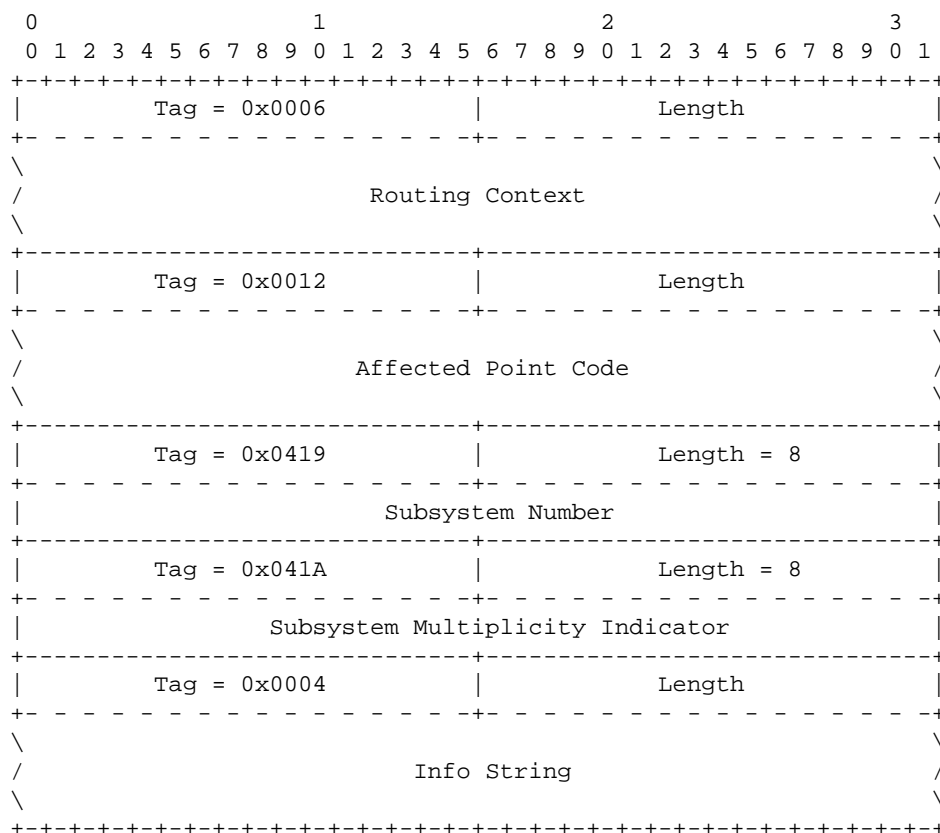

The *DAVA* message can contain the following parameters:

Parameters		
<i>Routing Context</i>	Mandatory	
<i>Affected Point Code</i>	Mandatory	
<i>Subsystem Number</i>	Conditional	*1
<i>Subsystem Multiplicity Indicator</i>	Optional	*2
<i>Info String</i>	Optional	

Note 1: The *Subsystem Number* parameter **SHALL** be present in the **DAVA** message when indicating the availability of a subsystem, and **SHALL NOT** be present when indicating the availability of a signalling point.

Note 2: The *Subsystem Multiplicity Indicator* parameter **SHOULD NOT** be present in the **DAVA** message when the *Subsystem Number* parameter is not also present.

3.5.3. Destination State Audit (DAUD)

The **Destination State Audit (DAUD)** message is sent from an ASP to an SG to query the availability state of routes to SS7 SCCP subsystems or signalling points. A **DAUD** message **MAY** be sent periodically after the ASP has received a **DUNA** message, and until a **DAVA** is received for the affected subsystem or signalling point. The **DAUD** message can also be sent when an ASP recovers from isolation from the SG.

When the **DAVA** message contains the *Subsystem Number* parameter, the message is soliciting responses that correspond to the ITU-T [Q.711] and ANSI [T1.112] 'N-STATE' primitive. When the **DAVA** message does not contain the *Subsystem Number* parameter, message, the message soliciting responses that correspond to the ITU-T [Q.711] and ANSI [T1.112] 'N-PCSTATE' primitive.

The *DAUD* message is formatted as follows:

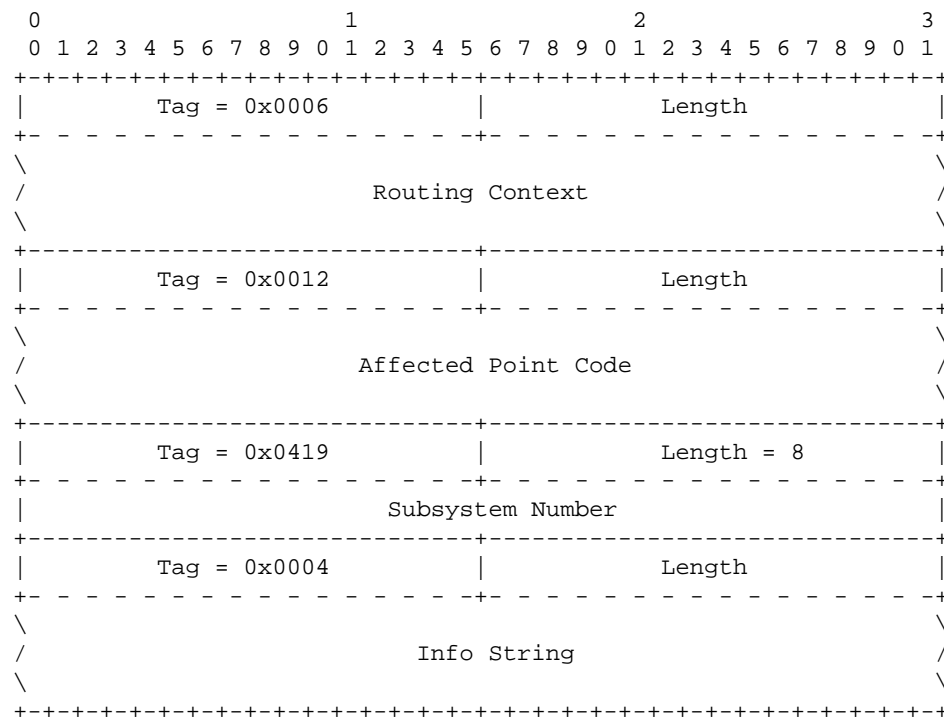

The *DAUD* message can contain the following parameters:

Parameters	
<i>Routing Context</i>	Mandatory
<i>Affected Point Code</i>	Mandatory
<i>Subsystem Number</i>	Conditional *1
<i>Info String</i>	Optional

Note 1: The *Subsystem Number* parameter **SHALL** be present in the **DAVA** message when auditing the status of a subsystem, and **SHALL NOT** be present when auditing the status of a signalling point.

3.5.4. Network Congestion (SCON)

The **Network Congestion (SCON)** message is sent from an SG to all concerned ASPs to indicate that the congestion level in the SS7 network to a specified subsystem or signalling point has changed. The TC-User at the ASP is expected to stop traffic at the indicated importance level to TC-User peers at the affected subsystems or signalling points via the SG initiating the **SCON** message.

When the **SCON** message contains the *Subsystem Number* parameter, the message corresponds to the ITU-T [Q.711] and ANSI [T1.112] 'N-STATE' primitive. When the **SCON** message does not contain the *Subsystem Number* parameter, message, the message corresponds to the ITU-T [Q.711] and ANSI [T1.112] 'N-PCSTATE' primitive.

The *SCON* message is formatted as follows:

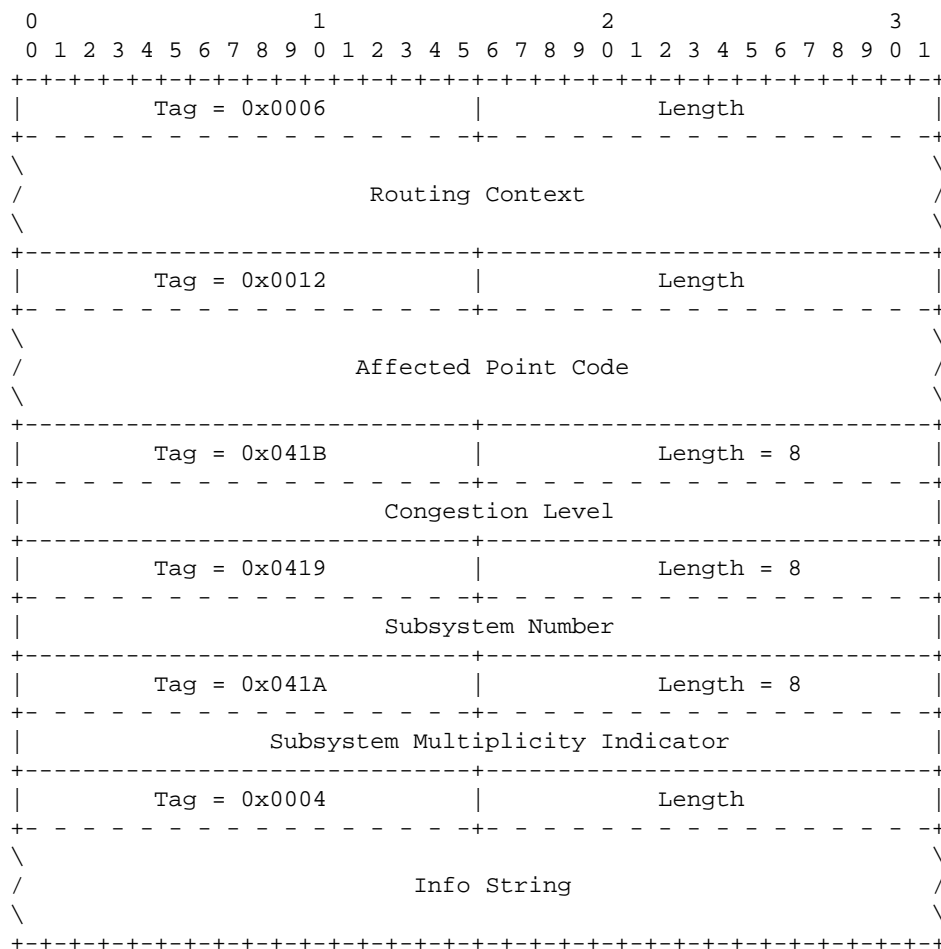

The *SCON* message can contain the following parameters:

Parameters	
<i>Routing Context</i>	Mandatory
<i>Affected Point Code</i>	Mandatory
<i>Congestion Level</i>	Mandatory
<i>Subsystem Number</i>	Optional *1

Subsystem Multiplicity Indicator Optional *2
Info String Optional

Note 1: The *Subsystem Number* parameter **SHALL** be present in the **SCON** message when indicating the congestion of a subsystem, and **SHALL NOT** be present when indicating the congestion of a signalling point.

Note 2: The *Subsystem Multiplicity Indicator* parameter **SHOULD NOT** be present in the **SCON** message when the *Subsystem Number* parameter is not also present.

3.5.5. Destination User Part Unavailable (DUPU)

The **Destination User Part Unavailable (DUPU)** message is sent from an SG to all concerned ASPs to indicate the unavailability of an SS7 SCCP.

The **DUPU** message corresponds to the ITU [Q.711] and ANSI [T1.112] ‘N-PCSTATE’ primitive.

The *DUPU* message is formatted as follows:

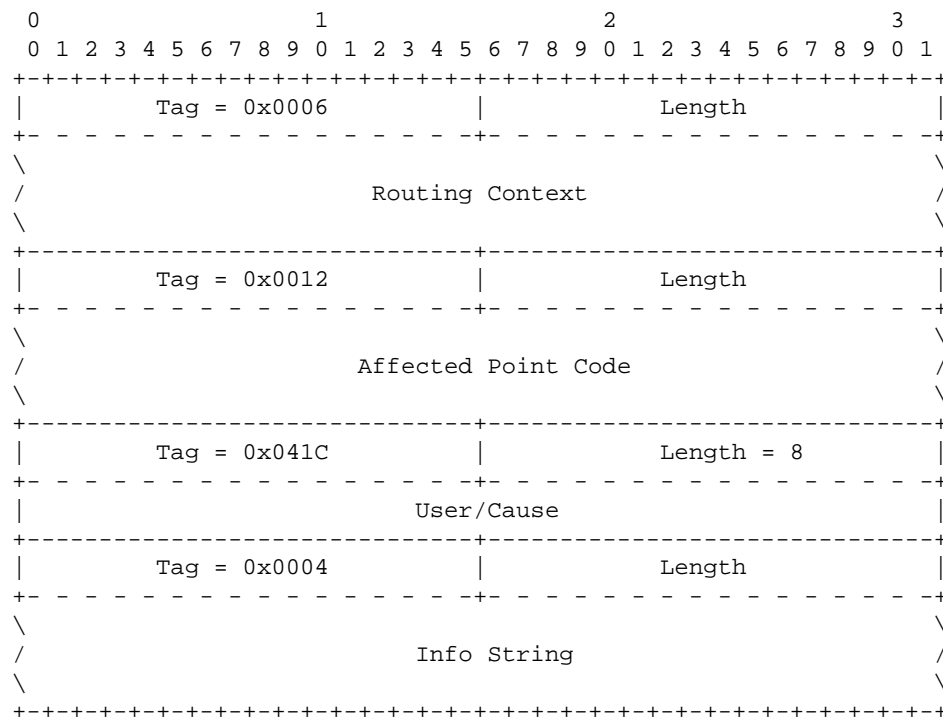

The *DUPU* message can contain the following parameters:

Parameters	
<i>Routing Context</i>	Mandatory
<i>Affected Point Code</i>	Mandatory
<i>User/Cause</i>	Mandatory *1
<i>Info String</i>	Optional

Note 1: The *User* field of the *User/Cause* parameter must indicate an SCCP MTP-User part and can be ignored by the receiver of the **DUPU** message.

3.5.6. Destination Restricted (DRST)

The **Destination Restricted (DRST)** message is sent from an SG to all concerned ASPs to indicate one of the following:

- (1) A replicated subsystem is requesting that the TUA layer at the ASP accept transactions for the affected subsystem. The TUA layer at the ASP is expected to determine whether it can accept the traffic of the affected subsystem and respond with a **DRST** message.
- (2) An SG representing a signalling transfer point is requesting that the TUA layer at the ASP routing message traffic via an alternate SG if possible.

The **DRST** is sent from an ASP to an SG in response to a **DRST** from the SG when the TUA layer at the ASP is prepared to accept traffic for the affected subsystem.

When the **DRST** message contains the *Subsystem Number* parameter, this message corresponds to the ITU [Q.711] and ANSI [T1.112] 'N-COORD' primitive. When the **DRST** message contains the *Subsystem Multiplicity Indicator* parameter, the message corresponds to the 'Request' and 'Indication' forms of the 'N-COORD' primitive; when it does not include the parameter, it corresponds to the 'Response' and 'Confirm' forms of the 'N-COORD' primitive.

When the **DRST** message does not contain the *Subsystem Number* parameter, the message corresponds to the ITU [Q.704] and ANSI [T1.111] 'Transfer Restricted' message.

The *DRST* message is formatted as follows:

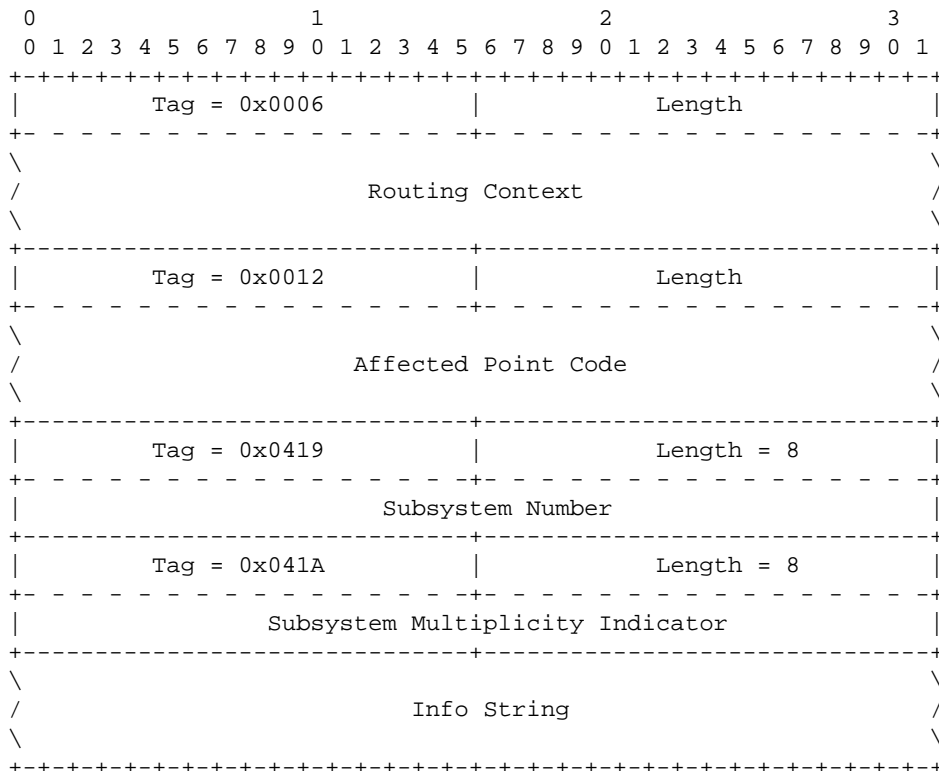

The *DRST* message can contain the following parameters:

Parameters		
<i>Routing Context</i>	Mandatory	
<i>Affected Point Code</i>	Mandatory	*1
<i>Subsystem Number</i>	Conditional	*2
<i>Subsystem Multiplicity Indicator</i>	Conditional	*3
<i>Info String</i>	Optional	

Note 1: The *Affected Point Code* parameter refers to the node which has become restricted or which has requested coordinated service outage.

Note 2: The *Subsystem Number* parameter **SHALL** be present in the **SCON** message when requesting or responding to a subsystem coordinated service outage, and **SHALL NOT** be present when indicating the restriction of a signalling point.

Note 3: The *Subsystem Multiplicity Indicator* parameter **SHOULD NOT** be present in the **SCON** message when the *Subsystem Number* parameter is not also present. The *Subsystem Multiplicity Indicator* parameter **SHALL** be present in the **SCON** message when requesting or indicating a coordinated service outage, and **SHALL NOT** be present when responding to or confirming a coordinated service outage.

3.6. Application Server Process State Maintenance (ASPSM) Messages

3.6.1. ASP Up (UP)

The *ASP Up (UP)* message is used to indicate to a remote TUA peer that the Adaptation layer is up and running.

The *ASP UP* message is formatted as follows:

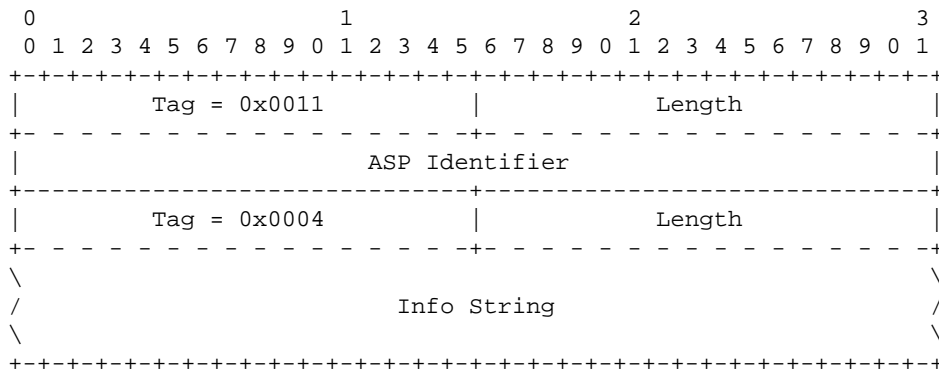

The *ASP UP* message can contain the following parameters:

Parameters		
<i>ASP Identifier</i>	Conditional	*1
<i>Info String</i>	Optional	

Note 1: ASP Identifier **MUST** be used where the IPSP/SGP cannot identify the ASP by pre-configured address/port number information (e.g, where an ASP is resident on a Host using dynamic address/port number assignment).

3.6.2. ASP Up Ack (UP ACK)

The *ASP Up Ack (UP ACK)* message is used to acknowledge an *ASP UP* message received from a remote TUA peer.

The *ASP UP ACK* message is formatted as follows:

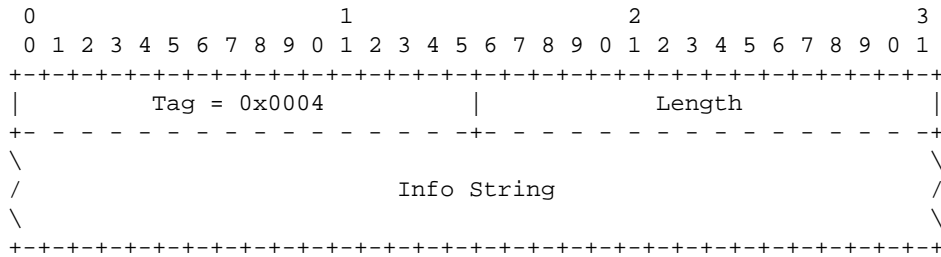

The *ASP UP ACK* message can contain the following parameters:

Parameters	
<i>Info String</i>	Optional

3.6.3. ASP Down (DOWN)

The *ASP Down (DOWN)* message is used to indicate to a remote TUA peer that the adaptation layer is not running.

The *ASP DOWN* message is formatted as follows:

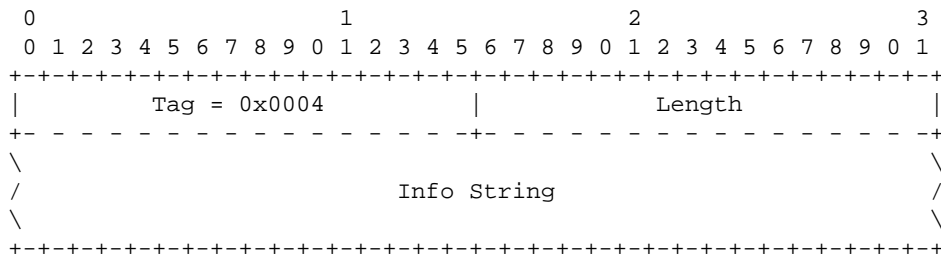

The *ASP DOWN* message can contain the following parameters:

Parameters	
<i>Info String</i>	Optional

3.6.4. ASP Down Ack (DOWN ACK)

The *ASP Down Ack (DOWN ACK)* message is used to acknowledge an *ASP DOWN* message received from a remote TUA peer.

The *ASP DOWN ACK* message is formatted as follows:

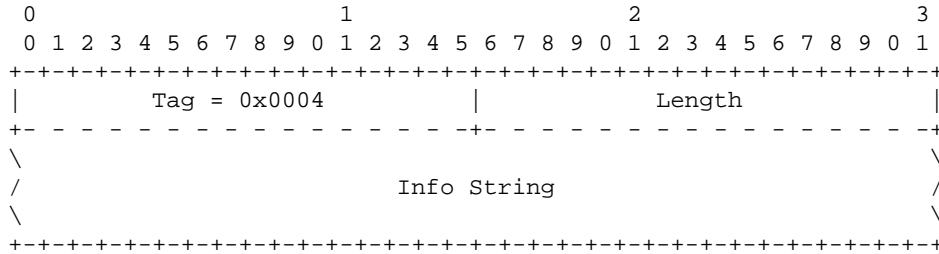

The *ASP DOWN ACK* message can contain the following parameters:

Parameters	
<i>Info String</i>	Optional

Note: The *ASP DOWN ACK* message will always be sent to acknowledge an *ASP DOWN* message.

3.6.5. Heartbeat (BEAT)

The *Heartbeat (BEAT)* message is optionally used to ensure that the TUA peers are still available to each other.

The *BEAT* message is formatted as follows:

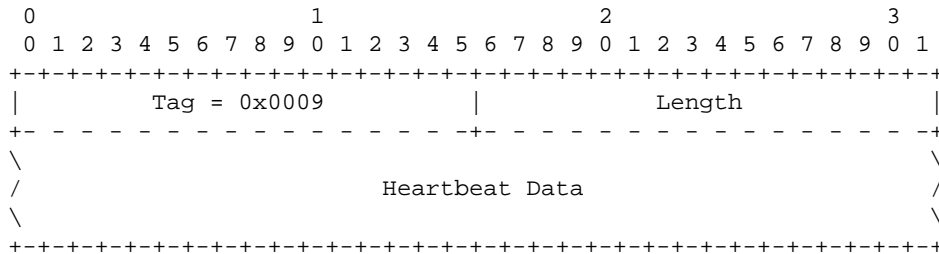

The *BEAT* message can contain the following parameters:

Parameters	
<i>Heartbeat Data</i>	Optional

3.6.6. Heartbeat Ack (BEAT ACK)

The *Heartbeat ACK (BEAT ACK)* message is sent in response to a *BEAT* message. A peer **MUST** send a *BEAT ACK* in response to a *BEAT* message. It includes all the parameters of the received *BEAT* message, with-out any change.

The *BEAT ACK* message is formatted as follows:

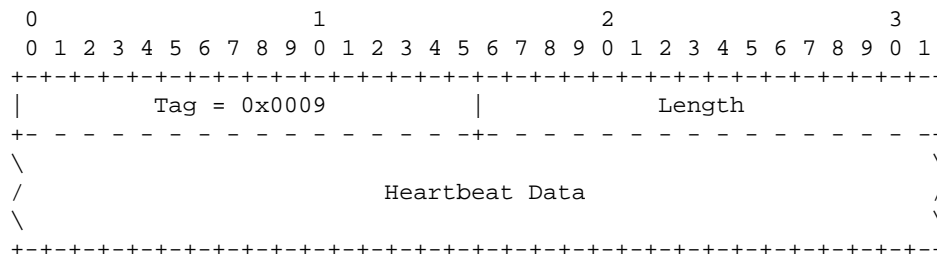

The *BEAT ACK* message can contain the following parameters:

Parameters	
<i>Heartbeat Data</i>	Optional

3.7. Application Server Process Traffic Maintenance (ASPTM) Messages

3.7.1. ASP Active (ASPAC)

The *ASP Active (ASPAC)* message is sent by an ASP to indicate to a remote TUA peer that it is Active and ready to process signalling traffic for a particular Application Server.

The *ASPAC* message is formatted as follows:

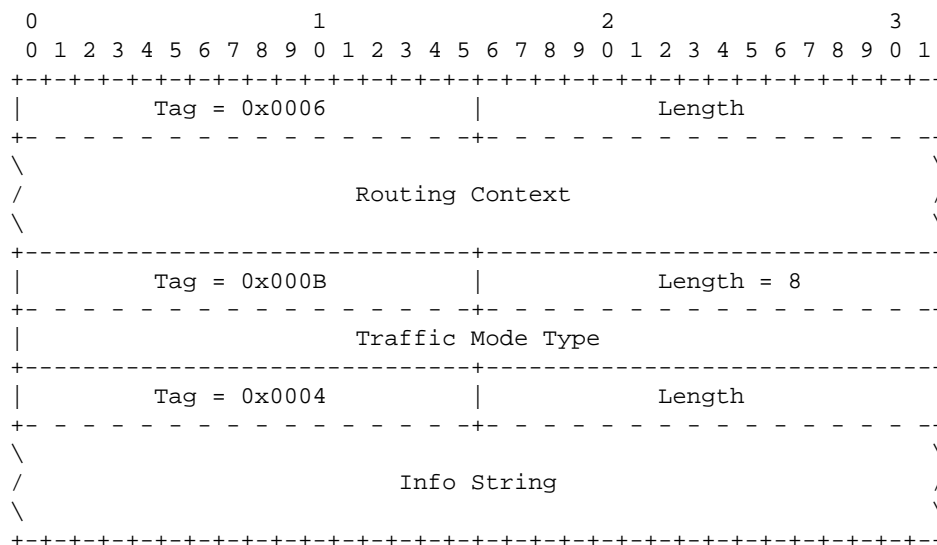

The *ASPAC* message can contain the following parameters:

Parameters		
<i>Routing Context</i>	Conditional	*1
<i>Traffic Mode Type</i>	Optional	*2
<i>Info String</i>	Optional	

Note 1: When an ASP is registered or configured for multiple AS with an SG, the Routing Context associated with the AS whose activation is being requested **MUST** be placed in the *ASPAC* message.

Note 2: The Traffic Mode Type parameter is not necessary in the *ASPAC* message when both peers are aware of the traffic mode of the AS by configuration or registration.

3.7.2. ASP Active Ack (ASPAC ACK)

The *ASP Active Ack (ASPAC)* Ack message is used to acknowledge an *ASPAC* message received from a remote TUA peer.

The *ASPAC ACK* message is formatted as follows:

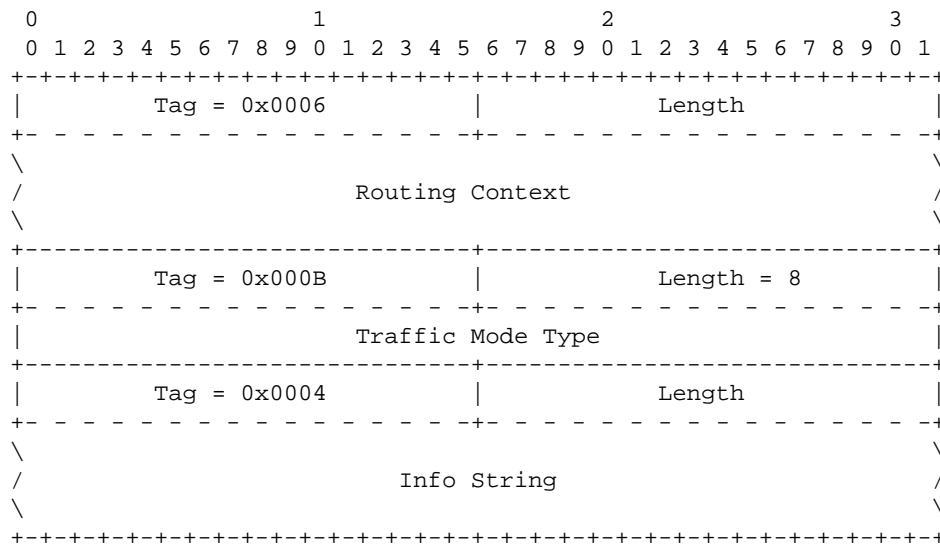

The *ASPAC ACK* message can contain the following parameters:

Parameters	
<i>Routing Context</i>	Conditional *1
<i>Traffic Mode Type</i>	Optional
<i>Info String</i>	Optional

Note 1: When an ASP is registered or configured for multiple AS with an SG, the Routing Context associated with the AS whose activation is being acknowledged **MUST** be placed in the *ASPAC ACK* message.

3.7.3. ASP Inactive (ASPIA)

The *ASP Inactive (ASPIA)* message is sent by an ASP to indicate to a remote TUA peer that it is no longer processing signalling traffic within a particular Application Server.

The *ASPIA* message is formatted as follows:

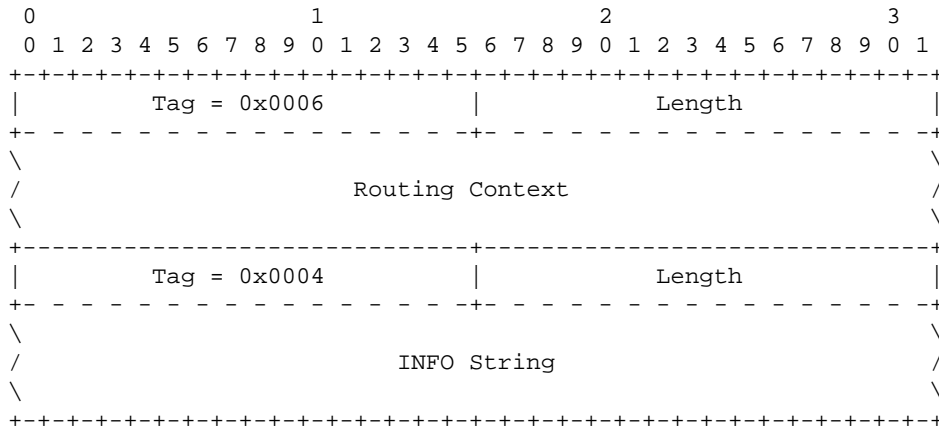

The ASPIA message can contain the following parameters:

Parameters

<i>Routing Context</i>	Conditional	*1
<i>INFO String</i>	Optional	

Note 1: When an ASP is registered or configured for multiple AS with an SG, the Routing Context associated with the AS whose deactivation is being requested **MUST** be placed in the ASPIA message.

3.7.4. ASP Inactive Ack (ASPIA ACK)

The *ASP Inactive Ack (ASPIA ACK)* message is used to acknowledge an ASPIA message received from a remote TUA peer.

The ASPIA message is formatted as follows:

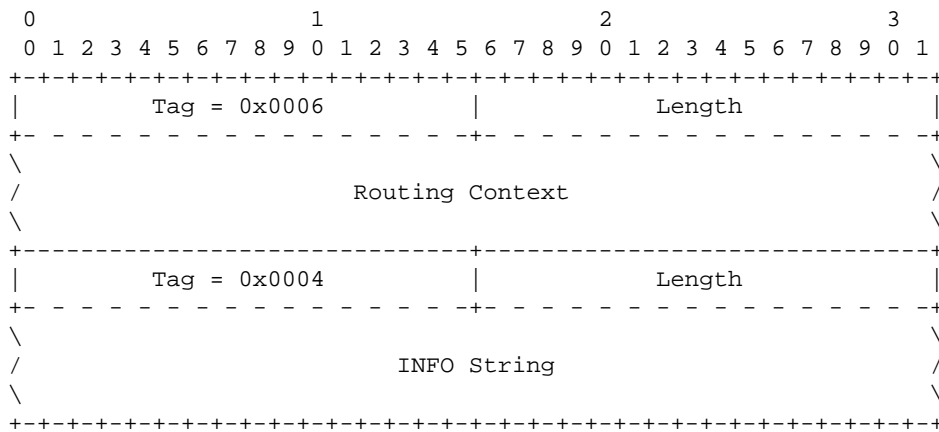

The ASPIA message can contain the following parameters:

Parameters

<i>Routing Context</i>	Conditional	*1
------------------------	-------------	----

INFO String

Optional

Note 1: When an ASP is registered or configured for multiple AS with an SG, the Routing Context associated with the AS whose deactivation is being acknowledged **MUST** be placed in the *ASPIA ACK* message.

3.8. Management (MGMT) Messages

3.8.1. Error (ERR)

The *Error (ERR)* message is used by a TUA peer to indicate an error situation. *ERR* messages **MUST NOT** be generated in response to other *ERR* messages.

The *ERR* message is formatted as follows:

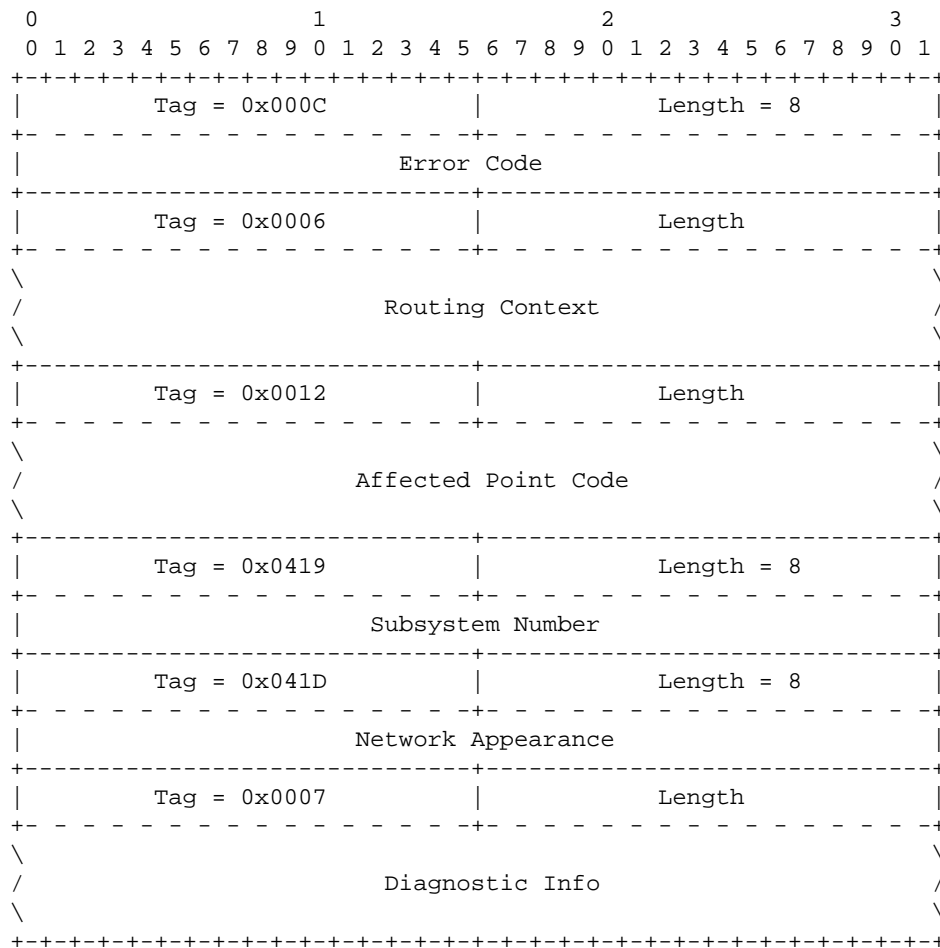

The *ERR* message can contain the following parameters:

Parameters		
<i>Error Code</i>	Mandatory	
<i>Routing Context</i>	Conditional	*1
<i>Affected Point Code</i>	Conditional	*2

<i>Subsystem Number</i>	Conditional	*3
<i>Network Appearance</i>	Conditional	*4
<i>Diagnostic Info</i>	Conditional	*5

- Note 1: When the Error Code is "Invalid Routing Context," the Routing Context parameter **MUST** contain the invalid routing context value(s).
- Note 2: When the Error Code is "Destination Status Unknown" or "Subsystem Status Unknown," the Affected Point Code parameter **MUST** contain the point codes for which status is unknown or unauthorized.
- Note 3: When the Error Code is "Subsystem Status Unknown," the Subsystem Number parameter **MUST** contain the subsystem for which status is unknown or unauthorized.
- Note 4: When the Error Code is "Invalid Network Appearance," the Network Appearance parameter **MUST** contains the invalid network appearance value.
- Note 5: The Diagnostic Info parameter **SHOULD** contain at least the first 40 bytes of the message that caused the ERR message to be sent.

3.8.2. Notify (NTFY)

The Notify message is used to provide an autonomous indication of TUA events at an SG or IPSP to an ASP.

The *NTFY* message is formatted as follows:

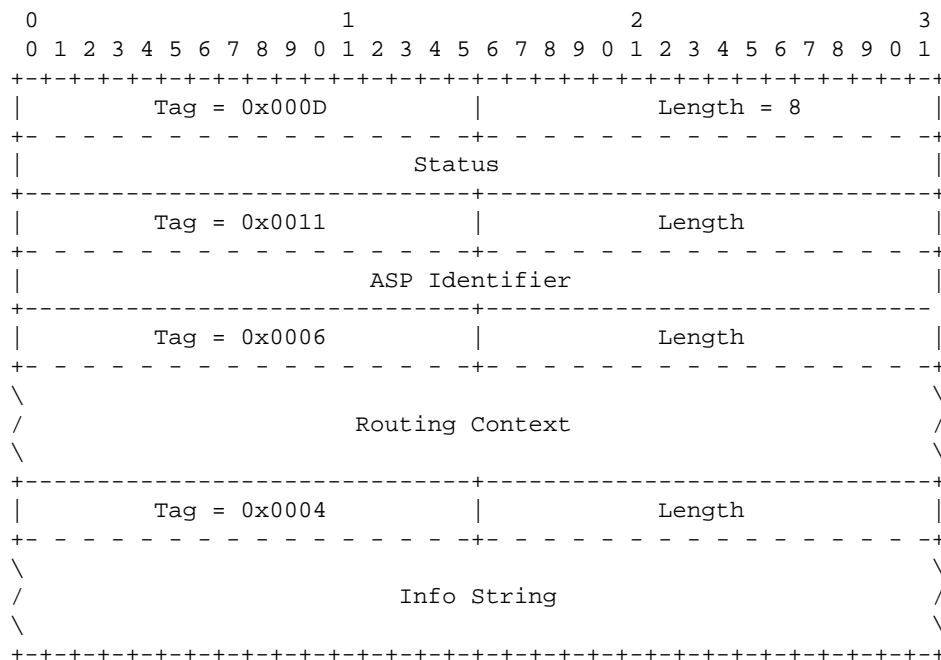

The *NTFY* message can contain the following parameters:

Parameters

<i>Status</i>	Mandatory	
<i>ASP Identifier</i>	Conditional	*1
<i>Routing Context</i>	Conditional	*2
<i>Info String</i>	Optional	

- Note 1: ASP Identifier **MUST** be used where the IPSP/SGP cannot identify the ASP by pre-configured address/port number information (e.g, where an ASP is resident on a Host using dynamic address/port number assignment) and the Status parameter is set to "Alternate ASP Active" or "ASP Failure".
- Note 2: When an ASP is registered or configured for multiple AS with an SG, to identify the Application Server, the Routing Context associated with the AS whose state is being notified **MUST** be placed in the *NTFY* message when the Status parameter is set to "AS_State_Change".

3.9. Routing Key Management (RKM) Messages

Routing Key Management (RKM) messages are used to manage the Routing Keys that are used by an SG to direct traffic toward an Application Server.

3.9.1. Registration Request (REG REQ)

The *Registration Request (REG REQ)* message is sent by an ASP to indicate to a remote TUA peer that it wishes to register one or more given Routing Keys with the remote peer. Typically, an ASP would send this message to an SGP, and expects to receive a REG RSP message in return with an associated Routing Context value.

The *REG REQ* message is formatted as follows:

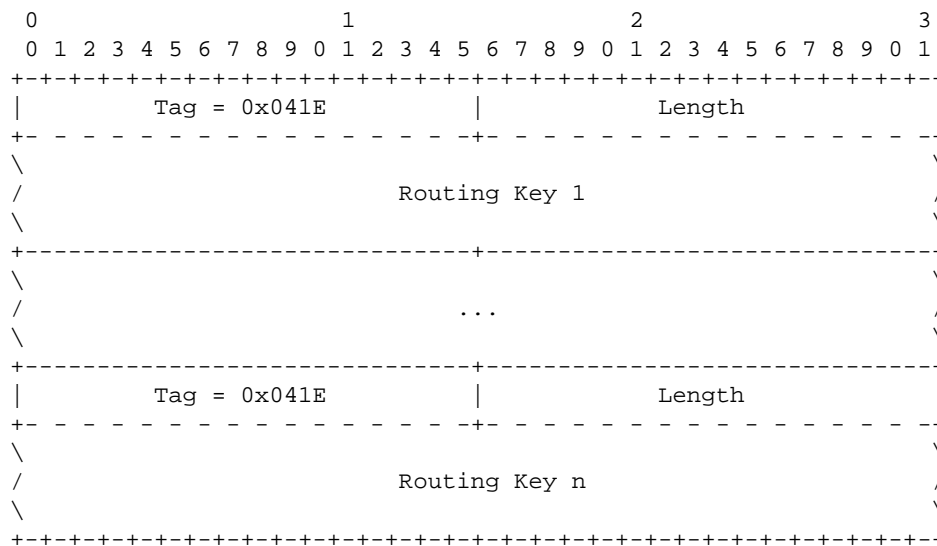

The *REG REQ* message can contain the following parameters:

Parameters	
<i>Routing Key</i>	Mandatory *1

- Note 1: One or more Routing Key parameters **MAY** be included in a single *REG REQ* message. Whereas it is **OPTIONAL** for an implementation to be able to generate a *REG REQ* message with more than one

Routing Key parameter, it is **REQUIRED** that the implementation be able to receive multiple Routing Key parameters in a single *REG REQ* message.

3.9.2. Registration Response (REG RSP)

The *Registration Response (REG RSP)* message is sent by an SG to an ASP to indicate the result of a previous *REG REQ* from an ASP. When successful, the *REG RSP* message contains the Routing Context assigned to the one or more Routing Keys that were presented in the *REG REQ message*.

The *REG RSP* message is formatted as follows:

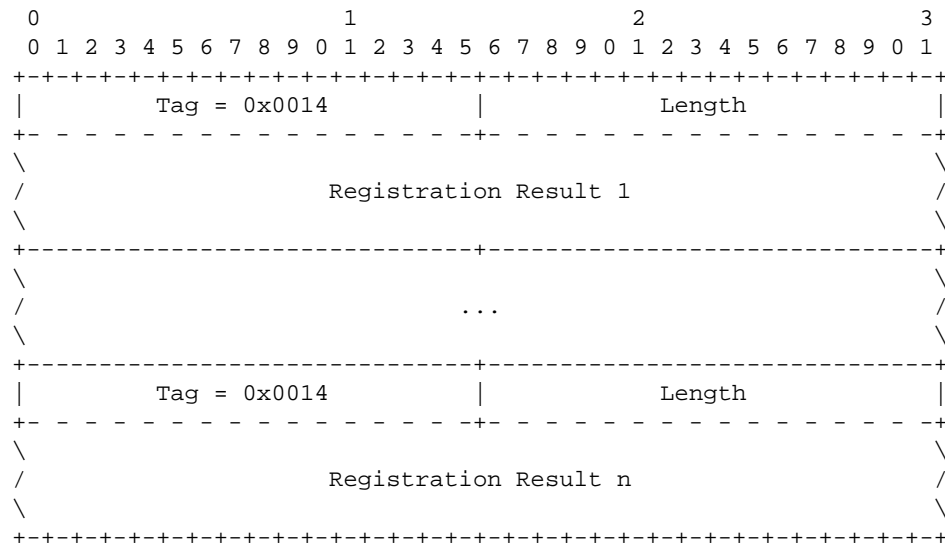

The *REG RSP* message can contain the following parameters:

Parameters		
<i>Registration Result</i>	Mandatory	*1

Note 1: *REG RSP* message. Whereas it is **OPTIONAL** for an implementation to be able to generate a *REG RSP* message with more than one Routing Key parameter, it is **REQUIRED** that the implementation be able to receive multiple Routing Key parameters in a single *REG RSP* message.

3.9.3. Deregistration Request (DEREG REQ)

The *Deregistration Request (DEREG REQ)* message is sent by an ASP to indicate to a remote TUA peer that it wishes to deregister a given Routing Key as identified by the given Routing Context. Typically, an ASP would send this message to an SGP, and expects to receive a *DEREG RSP* message in return with the associated Routing Context value.

The *DEREG REQ* message is formatted as follows:

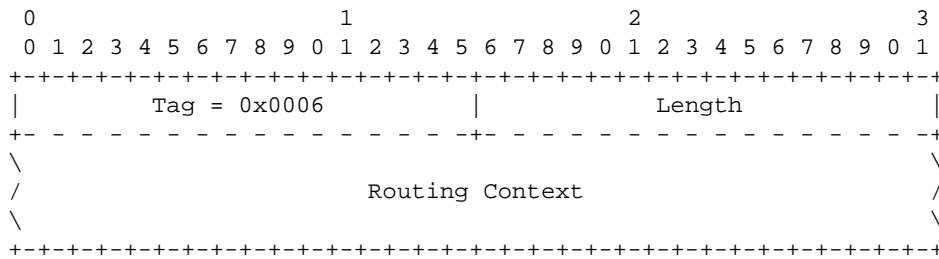

The *DEREG REQ* message contains the following parameters:

Parameters

<i>Routing Context</i>	Mandatory	*1
------------------------	-----------	----

Note 1: One or more Routing Context values **MAY** be included in the Routing Context parameter. Whereas it is **OPTIONAL** for an implementation to be able to generate a *DEREG REQ* message with multiple Routing Context values in the Routing Context parameter, it is **REQUIRED** that an implementation be able to receive multiple Routing Context values in the Routing Context parameter of the *DEREG REQ* message.

3.9.4. Deregistration Response (DEREG RSP)

The *Deregistration Response (DEREG RSP)* message is used as a response to the *DEREG REQ* message from a remote TUA peer.

The *DEREG REQ* message is formatted as follows:

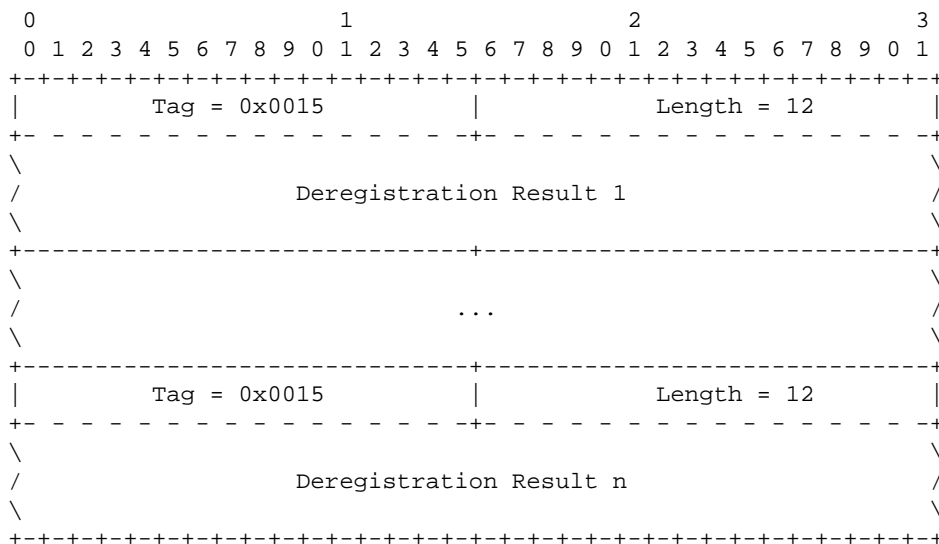

The *DEREG REQ* message contains the following parameters:

Parameters

<i>Deregistration Result</i>	Mandatory	*1
------------------------------	-----------	----

Note 1: One or more Deregistration Result parameters **MAY** be included in one *DEREG RSP* message. Whereas it is **OPTIONAL** for an implementation to be able to generate a *DEREG RSP* message with multiple Deregistration Result parameters, it is **REQUIRED** that an implementation be able to receive multiple Deregistration Result parameters in a single *DEREG RSP* message.

3.10. Common Parameters

These TLV parameters are common across the different adaptation layers:

Parameter Name	Parameter ID	Section
<i>Reserved</i>	0x0000	–
<i>Not used in TUA</i>	0x0001	–
<i>Not used in TUA</i>	0x0002	–
<i>Not used in TUA</i>	0x0003	–
<i>Info String</i>	0x0004	3.10.1
<i>Not used in TUA</i>	0x0005	–
<i>Routing Context</i>	0x0006	3.10.2
<i>Diagnostic Info</i>	0x0007	3.10.3
<i>Not used in TUA</i>	0x0008	–
<i>Heartbeat Data</i>	0x0009	3.10.4
<i>Not used in TUA</i>	0x000A	–
<i>Traffic Mode Type</i>	0x000B	3.10.5
<i>Error Code</i>	0x000C	3.10.6
<i>Status</i>	0x000D	3.10.7
<i>Not used in TUA</i>	0x000E	–
<i>Not used in TUA</i>	0x000F	–
<i>Not used in TUA</i>	0x0010	–
<i>ASP Identifier</i>	0x0011	3.10.8
<i>Affected Point Code</i>	0x0012	3.10.9
<i>Correlation Id</i>	0x0013	3.10.10
<i>Registration Result</i>	0x0014	3.10.11
<i>Deregistration Result</i>	0x0015	3.10.12
<i>Registration Status</i>	0x0016	3.10.13
<i>Deregistration Status</i>	0x0017	3.10.14
<i>Local Routing Key Identifier</i>	0x0018	3.10.15

3.10.1. Info String

The *Info String* parameter is optionally included in all MGMT, ASPSM and ASPTM messages to provide additional debugging or diagnostic information.

The *Info String* parameter is formatted as follows:

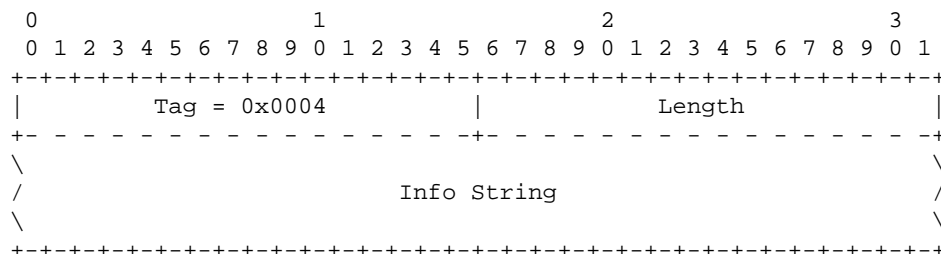

The *Info String* parameter contains the following fields:

Info String field: variable (ASCII string)

The *Info String* field can carry any meaningful UTF-8 [RFC 2279] character string along with the message. Length of the *Info String* field is from 0 to 255 characters. No procedures are presently identified for its use but implementations may use the *Info String* for debugging purposes.

3.10.2. Routing Context

The *Routing Context* parameter is included in all TUA SSNM, DH and CH messages as well as in MGMT, ASPTM, ASPSM that reference one or more Application Servers. The *Routing Context* parameter is used to uniquely identify an Application Server and Routing Key within an association between an SGP and ASP.

The *Routing Context* parameter is formatted as follows:

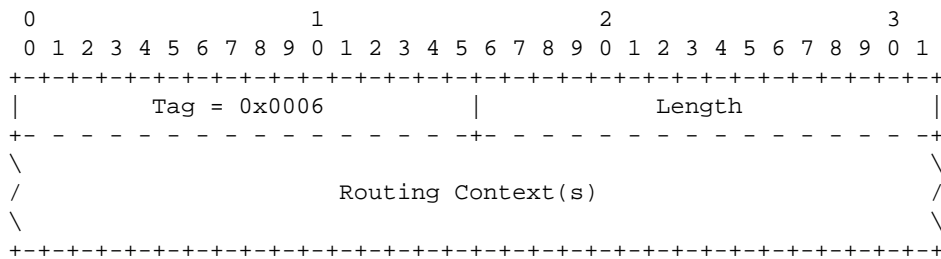

The *Routing Context* parameter can contain the following fields:

Routing Context field: list of 32-bit (unsigned integer)

The *Routing Context* field contains (a list of) 32-bit unsigned integers indexing the Application Server traffic that the sending ASP is configured or registered to receive. There is one-to-one relationship between a Routing Context value, an SG Routing Key and an Application Server [2]. If the Routing Context parameter is present, it **SHOULD** be the first parameter in the message as it defines the format and/or interpretation of the parameters containing a PC or SSN value.

3.10.3. Diagnostic Information

The *Diagnostic Info* parameter is used in the MGMT)Error (ERR) message to provide additional information concerning the message that generated an ERR message reply. The *Diagnostic Info* parameter **SHOULD** contain at least the first 40 bytes of the message that generated the error.

The *Diagnostic Info* parameter is formatted as follows:

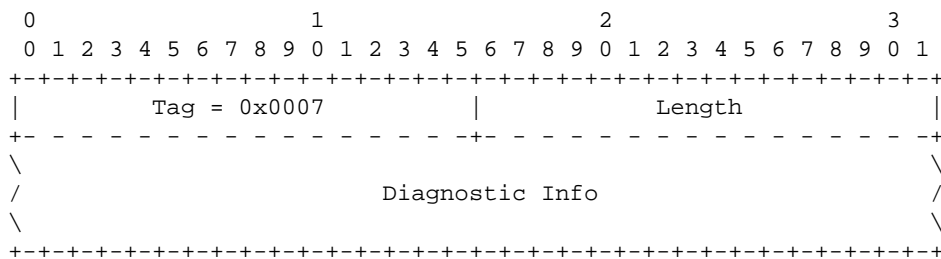

The *Diagnostic Info* parameter contains the following fields:

Diagnostic Info field: variable length (bytes)

The *Diagnostic Info* field can contain any information germane to the error condition, to assist in the identification of the error condition. The Diagnostic Info **SHOULD** be the first 40 bytes of the offending message.

3.10.4. Heartbeat Data

The **Heartbeat Data** parameter is used in the *BEAT* and *BEAT ACK* messages and contains whatever information the sender of the BEAT message chooses to include. Some uses for the Heartbeat Data parameter are described in Section 4.

The **Heartbeat Data** parameter is formatted as follows:

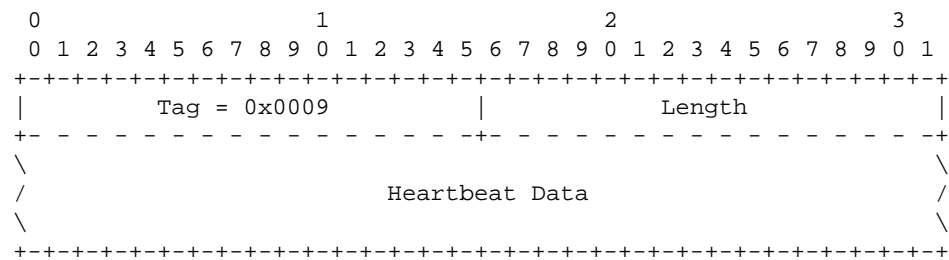

The **Heartbeat Data** parameter contains the following fields:

Heartbeat Data field: variable length (opaque)

The sending node defines the Heartbeat Data field contents. It may include a Heartbeat Sequence Number or Time-stamp, or other implementation specific details. The receiver of a *Heartbeat (BEAT)* message does not process this field as it is only of significance to the sender. The receiver **MUST** echo the content of the Heartbeat Data in a *BEAT ACK* message. The data field can be used to store information in the *Heartbeat (BEAT)* message useful to the sending node (e.g. the data field can contain a time stamp, a sequence number, etc.).

3.10.5. Traffic Mode Type

The *Traffic Mode Type* parameter indicates the fail-over and traffic distribution algorithm and procedures that will be used for an Application Server Process serving an Application Server. Each Application Server has associated with it only one Traffic Mode Type.

The *Traffic Mode Type* parameter is formatted as follows:

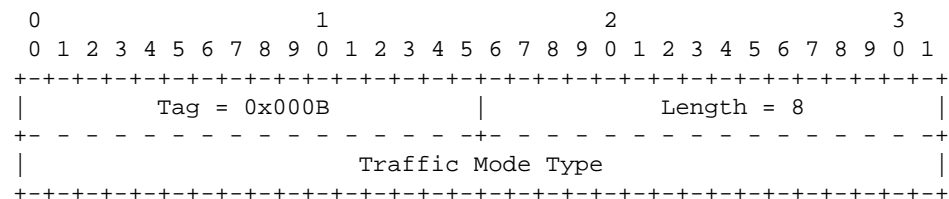

The *Traffic Mode Type* parameter contains the following fields:

Traffic Mode Type field: 32-bits (unsigned integer)

The Traffic Mode Type field identifies the traffic mode of operation of an ASP within an AS. The valid values for the Traffic Mode Type field are as follows:

- 1 Override
- 2 Load-share
- 3 Broadcast

Within a Routing Context, Override, Load-share Types and Broadcast cannot be mixed. The Override value indicates that the ASP is operating in Override mode, and that when the ASP becomes active for the Application Server, it will take over all traffic for the AS (i.e, primary/back-up operation), overriding any currently active ASP in the AS. In Load-share mode, when the ASP becomes active for the AS, the ASP will share in the traffic distribution with any other active ASPs. In Broadcast mode, when the ASP becomes active for the AS, the ASP will receive the same traffic as any other active ASPs.

3.10.6. Error Code

The *Error Code* parameter is used in the *Error (ERR)* message to indicate the reason that the *ERR* message was generated and, along with the other parameters in the *ERR* message, help to locate the problem that generated the error condition.

The *Error Code* parameter is formatted as follows:

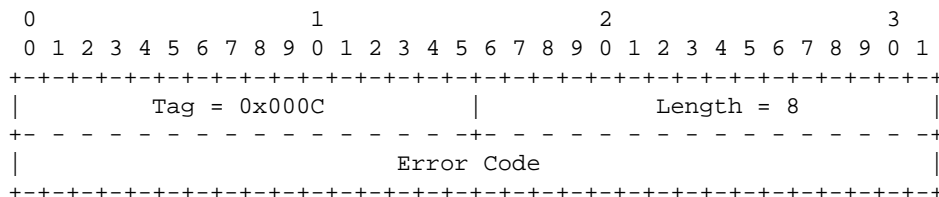

The *Error Code* parameter contains the following fields:

Error Code field: 32-bit (unsigned integer)

The *Error Code* field indicates the reason for the Error Message. The Error Code field value can be one of the following values:

- 1 Invalid Version
- 3 Unsupported Message Class
- 4 Unsupported Message Type
- 5 Unsupported Traffic Handling Mode
- 6 Unexpected Message
- 7 Protocol Error
- 9 Invalid Stream Identifier
- 13 Refused - Management Blocking
- 14 ASP Identifier Required
- 15 Invalid ASP Identifier

- 17 Invalid Parameter Value
- 18 Parameter Field Error
- 19 Unexpected Parameter
- 20 Destination Status Unknown
- 21 Invalid Network Appearance
- 22 Missing Parameter
- 25 Invalid Routing Context
- 26 No Configured AS for ASP
- 27 Subsystem Status Unknown

The "Invalid Version" error is sent if a message was received with an invalid or unsupported version. The *ERR* message contains the supported version in the Common header. The *ERR* message could optionally provide the supported version in the Diagnostic parameter.

The "Unsupported Message Class" error is sent if a message with an unexpected or unsupported Message Class is received.

The "Unsupported Message Type" error is sent if a message with an unexpected or unsupported Message Type is received.

The "Unsupported Traffic Handling Mode" error is sent by a SGP if an ASP sends an *ASP Active (ASPAC)* message with an unsupported Traffic Mode Type or a Traffic Mode Type that is inconsistent with the presently configured mode for the Application Server. An example would be a case in which the SGP did not support load-sharing.

The "Unexpected Message" error **MAY** be sent if a defined and recognized message is received that is not expected in the current state (in some cases the ASP may optionally silently discard the message and not send an *ERR* message). For example, silent discard is used by an ASP if it received a TUA CH or DH message from an SGP while it was in the ASP-INACTIVE state. If the Unexpected message contained Routing Context(s), the Routing Context(s) **SHOULD** be included in the *ERR* message.

The "Protocol Error" error is sent for any protocol anomaly (i.e., reception of a parameter that is syntactically correct but unexpected in the current situation).

The "Invalid Stream Identifier" error is sent if a message is received on an unexpected SCTP stream (e.g, a Management message was received on a stream other than "0", or a TUA DH or CH message was received on stream "0").

The "Refused - Management Blocking" error is sent when an *ASP Up (ASPUP)* or *ASP Active (ASPAC)* message is received and the request is refused for management reasons (e.g, management lockout"). If this error is in response to an *ASP Active (ASPAC)* message, the Routing Context(s) in the *ASP Active (ASPAC)* message **SHOULD** be included in the *ERR* message.

The "ASP Identifier Required" is sent by a SGP in response to an *ASP Up (ASPUP)* message which does not contain an ASP Identifier parameter when the SGP requires one. The ASP **SHOULD** resend the *ASP Up (ASPUP)* message with an ASP Identifier.

The "Invalid ASP Identifier" is sent by a SGP in response to an *ASP Up (ASPUP)* message with an invalid (i.e., non-unique) ASP Identifier.

The "Invalid Parameter Value" error is sent if a message is received with an invalid parameter value (e.g, a *DUPU* message was received with a Mask value other than "0").

The "Parameter Field Error" would be sent if a message is received with a parameter having a wrong length field.

The "Unexpected Parameter" error would be sent if a message contains an invalid parameter.

The "Destination Status Unknown" Error **MAY** be sent if a DAUD is received at an SG inquiring of the availability or congestion status of a destination, and the SG does not wish to provide the status (e.g, the sender is not authorized to know the status). For this error, the invalid or unauthorized Point Code(s) **MUST** be included along with any Network Appearance or Routing Context associated with the Point Code(s) from the *DAUD* message.

The "Invalid Network Appearance" error is sent by a SGP if an ASP sends a message with an invalid (not configured) Network Appearance value. For this error, the invalid (not configured) Network Appearance **MUST** be included in the Network Appearance parameter in the *ERR* message.

The "Missing Parameter" error is sent if a mandatory parameter was not included in a message.

The "Invalid Routing Context" error is sent if a message is received from a peer with an invalid (not configured) Routing Context value, or if a message is received from a peer without a Routing Context parameter and it is not known by configuration data which Application Servers are referenced. For this error, the invalid Routing Context(s) **MUST** be included in the *ERR* message.

The "No Configured AS for ASP" error is sent if a message is received from a peer without a Routing Context parameter and it is not known by configuration data which Application Servers are referenced.

The "Subsystem Status Unknown" Error **MAY** be sent if a DAUD is received at an SG inquiring of the availability or congestion status of a subsystem, and the SG does not wish to provide the status (e.g, the sender is not authorized to know the status). For this error, the invalid or unauthorized Point Code and Subsystem Number **MUST** be included along with any Network Appearance or Routing Context associated with the Point Code and Subsystem Number from the *DAUD* message.

3.10.7. Status

The Status parameter identifies the type of the status that is being notified in a *Notify (NTFY)* message and the Status ID.

The *Status* parameter is formatted as follows:

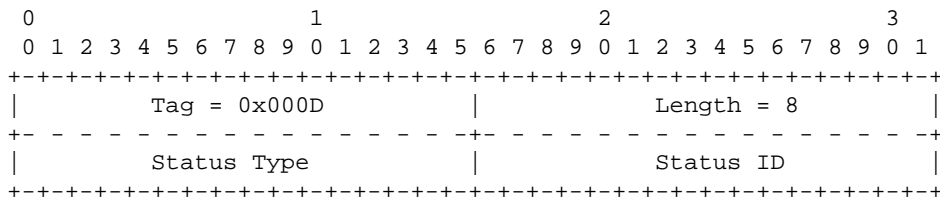

The *Status* parameter contains the following fields:

Status Type field: 16-bits (unsigned integer)

The valid values for Status Type field are as follows:

- 1 Application Server state change (AS_State_Change)
- 2 Other

Status ID field: 16-bits (unsigned integer)

The Status ID parameter contains more detailed information for the notification, based on the value of the Status Type.

(1) If the Status Type is "AS_State_Change", then the Status ID values are as follows:

- 1 reserved
- 2 Application Server Inactive (AS-Inactive)
- 3 Application Server Active (AS-Active)
- 4 Application Server Pending (AS-Pending)

These notifications are sent from an SGP to an ASP upon a change in status of a particular Application Server. The value reflects the new state of the Application Server.

(2) If the Status Type is "Other", then the following Status Information values are defined:

- 1 Insufficient ASP resources active in AS
- 2 Alternate ASP Active
- 3 ASP failure

These notifications are not based on the SGP reporting the state change of an ASP or AS. In the Insufficient ASP Resources case, the SGP is indicating to an "Inactive" ASP(s) in the AS that another ASP is required to handle the load of the AS (Load-sharing mode or Broadcast mode). For the Alternate ASP Active case, an ASP is informed when an alternate ASP transitions to the ASP-Active state in Override mode.

3.10.8. ASP Identifier

The *ASP Identifier* parameter is formatted as follows:

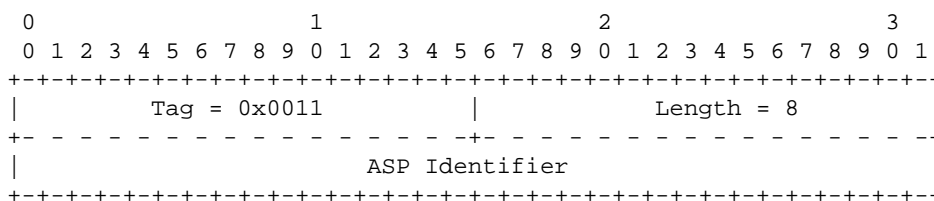

The *ASP Identifier* parameter contains the following fields:

ASP Identifier field: 32-bits (unsigned integer)

The ASP Identifier field contains a unique value that is locally significant among the ASPs that support an AS. The SGP should save the ASP Identifier to be used, if necessary, with the *Notify (NTFY)* message (see Section

3.7.2).

3.10.9. Affected Point Code

The *Affected Point Code* parameter is formatted as follows:

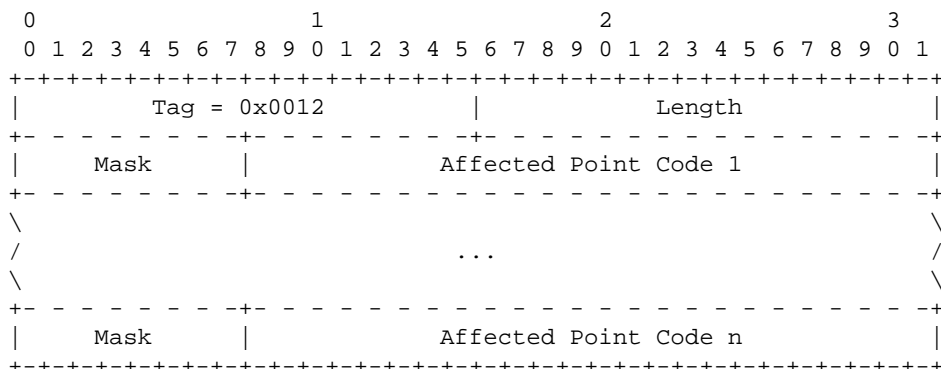

The *Affected Point Code* parameter contains the following fields:

Affected Destination Point Code field: n x 32-bits

The *Affected Point Code* parameter contains a list of one or more Affected Destination Point Code fields. It is **OPTIONAL** to generate an Affected Point Code parameter with more than one Affected Destination Point Code field, but it is **REQUIRED** to accept it.

Each Affected Destination Point Code field in the list contains the following fields:

Affected Point Code field: 24-bits (unsigned integer)

Each Affected Point Code field is a three-octet field to allow for up to 24-bit binary formatted SS7 Point Codes. Affected Point Codes that are less than 24-bits are padded on the left to the 24-bit boundary. The following examples show ANSI and ITU-T point codes:

ANSI 24-bit Point Code:

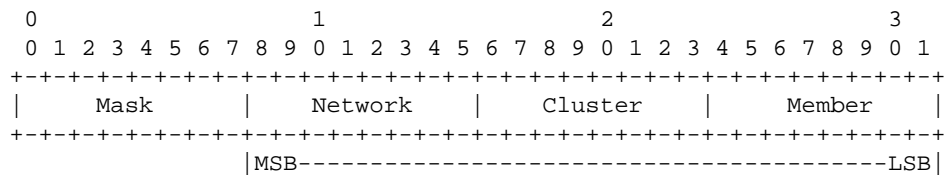

ITU-T 14-bit Point Code:

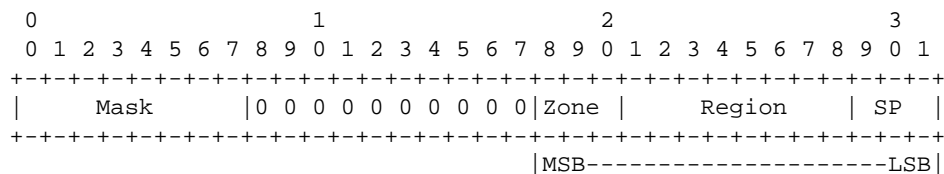

It is **OPTIONAL** for an implementation to generate an *Affected Point Code* parameter with more than one *Affected Point Code* field; but, the implementation **MUST** accept and process the *Affected Point Code* parameter with more than one *Affected Point Code* field.

Mask field: 8-bits (unsigned integer)

The Mask parameter can be used to identify a contiguous range of Affected Point Codes, independent of the point code format. Identifying a contiguous range of Affected Point Codes may be useful when a management event simultaneously affects the status of a series of destinations at an SG.

The Mask parameter is an integer representing a bit mask that can be applied to the related Affected PC field. The bit mask identifies how many bits of the Affected PC field are significant and which are effectively "wild-carded". For example, a mask of "8" indicates that the last eight bits of the PC is "wild-carded". For an ANSI 24-bit Affected PC, this is equivalent to signalling that all PCs in an ANSI Cluster are unavailable. A mask of "3" indicates that the last 3 bits of the PC is "wild-carded". For a 14-bit ITU Affected PC, this is equivalent to signalling that an ITU Region is unavailable.

A Mask value equal (or greater than) the number of bits in the Point Code indicates that the entire network access is affected: this is used to indicate network isolation to the ASP.

3.10.10. Correlation Id

The *Correlation Id* parameter is used to tag messages sent to an ASP in a Broadcast group as well as during fail-over.

The *Correlation Id* parameter is formatted as follows:

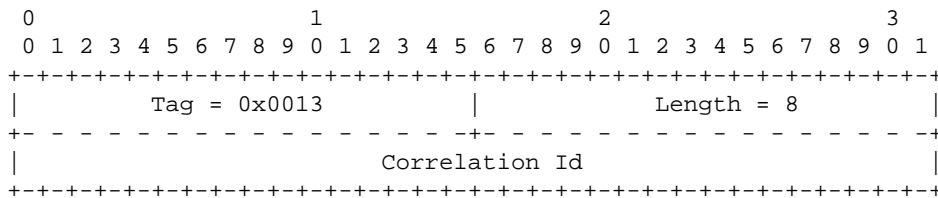

The *Correlation Id* parameter can contain the following fields:

Correlation Id field: 32-bits (unsigned integer)

The *Correlation Id* field contains a Correlation Id. The Correlation Id is a 32-bit identifier that is attached to the TUA Message Header to indicate to a newly entering ASP in a Broadcast AS where in the traffic flow of TUA messages the ASP is joining. It is attached to the TUA Message Header of the first DH or CH message sent to an ASP by an SG after sending an ASP Active Ack or otherwise starting traffic to an ASP. The Correlation Id is only significant within a Routing Context [3].

3.10.11. Registration Result

The *Registration Result* parameter is used to indicate the result of a successful or unsuccessful registration operation for a specific *Routing Key*.

The *Registration Result* parameter is formatted as follows:

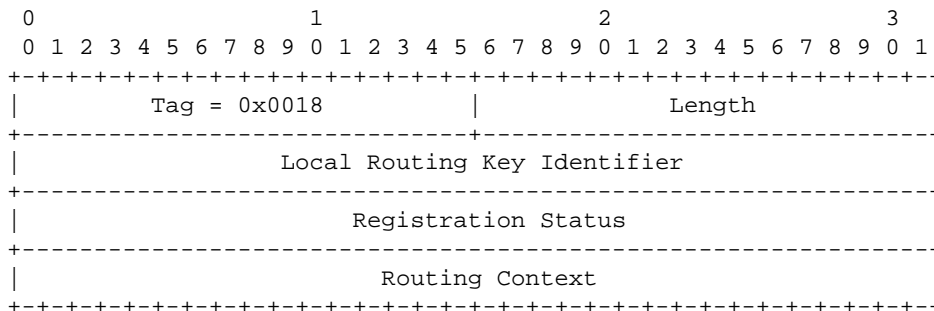

The *Registration Result* parameter can contain the following fields:

Local Routing Key Identifier: TLV

The *Local Routing Key Identifier* field is mandatory in the *Registration Result* parameter. The *Local Routing Key Identifier* field contains the same TLV formatted parameter value as found in the corresponding *Routing Key* parameter in the *Registration Request (REG REQ)* message.

Registration Status: TLV

The *Registration Status* field is mandatory in the *Registration Result* parameter. The *Registration Status* field indicates the success or reason for failure of the corresponding registration request. For details on the format of the *Registration Status* parameter, see Section 3.10.13.

Routing Context: TLV

The *Routing Context* field is mandatory in the *Registration Result* parameter. The *Routing Context* field contains the TLV formatted *Routing Context* parameter for the associated *Routing Key* if the registration was successful. If the registration was not successful, it is set to zero (0).

3.10.12. Deregistration Result

The *Deregistration Result* parameter is used to indicate the result of a successful or unsuccessful deregistration operation for a specific *Routing Key*.

The *Deregistration Result* parameter is formatted as follows:

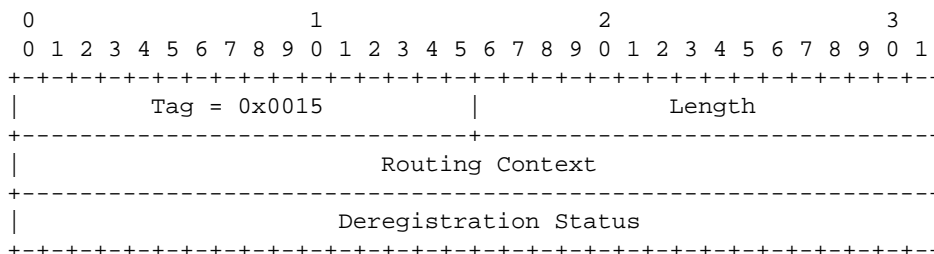

The *Deregistration Result* parameter can contain the following fields:

Routing Context: TLV

The *Routing Context* field is mandatory in the *Deregistration Result* parameter. The *Routing Context* field contains the same TLV formatted *Routing Context* parameter as found in the corresponding *Deregistration*

Request (DEREG REQ) message.

Deregistration Status: TLV

The *Deregistration Status* field is mandatory in the *Deregistration Result* parameter. The *Deregistration Status* field indicates the success or reason for failure of the corresponding deregistration request. For details on the format of the *Deregistration Status* parameter, see Section 3.10.14.

3.10.13. Registration Status

The *Registration Status* parameter is used to indicate the success or failure of a registration operation.

The *Registration Status* parameter is formatted as follows:

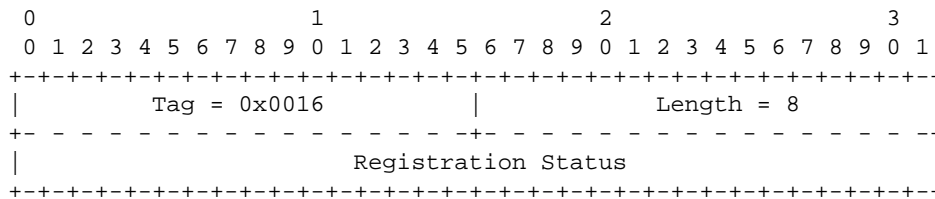

The *Registration Status* parameter can contain the following fields:

Registration Status: 32-bits (unsigned integer)

The *Registration Status* field indicates the success or the reason for failure of a registration request.

Its values can be:

- 0 Successfully Registered
- 1 Error - Unknown
- 2 Error - Invalid Destination Address
- 3 Error - Invalid Network Appearance
- 4 Error - Invalid Routing Key
- 5 Error - Permission Denied
- 6 Error - Cannot Support Unique Routing
- 7 Error - Routing Key not Currently Provisioned
- 8 Error - Insufficient Resources
- 9 Error - Unsupported RK parameter Field
- 10 Error - Unsupported/Invalid Traffic Mode Type
- 11 Error - Routing Key Change Refused

3.10.14. Deregistration Status

The *Deregistration Status* parameter is used to indicate the success or failure of a deregistration operation.

The *Deregistration Status* parameter is formatted as follows:

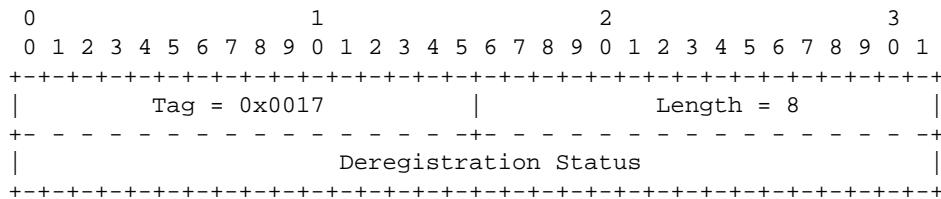

The *Deregistration Status* parameter can contain the following fields:

Deregistration Status: 32-bits (unsigned integer)

The *Deregistration Status* field indicates the success or the reason for failure of a deregistration request.

Its values can be:

- 0 Successfully Deregistered
- 1 Error - Unknown
- 2 Error - Invalid Routing Context
- 3 Error - Permission Denied
- 4 Error - Not Registered
- 5 Error - ASP Currently Active for Routing Context

3.10.15. Local Routing Key Identifier

The *Local Routing Key Identifier* parameter is used for correlating the *Routing Key* parameter in a specific *Registration Request (REG REQ)* message with the *Registration Result* parameter in the corresponding *Registration Response (REG RSP)* message.

The *Local Routing Key Identifier* parameter is formatted as follows:

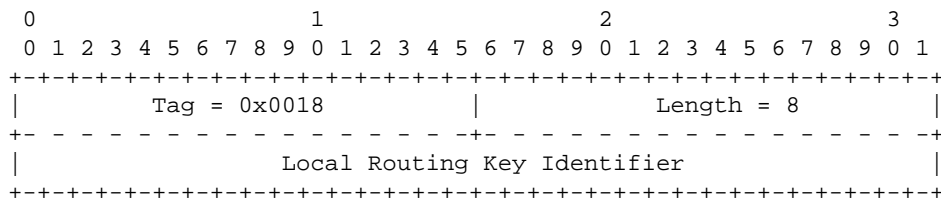

The *Local Routing Key Identifier* parameter can contain the following fields:

Local Routing Key Identifier: 32-bits (unsigned integer)

The *Local Routing Key Identifier* value is assigned by the ASP and is used to correlate the response in a *Registration Response (REG RSP)* message with the original registration request from the *Registration Request (REG REQ)* message. The *Local Routing Key Identifier* value must remain unique until the *REG RSP* message is received.

3.11. TUA-Specific parameters

These TLV parameters are specific to the TUA protocol:

Parameters used in DH Messages

Parameter Name	Parameter ID	Section
Dialogue Id	0x0401	3.11.1.1
Dialogue Flags	0x0402	3.11.1.2
Quality of Service	0x0403	3.11.1.3
Destination Address	0x0404	3.11.1.4
Originating Address	0x0405	3.11.1.5
Application Context Name	0x0406	3.11.1.6
User Information	0x0407	3.11.1.7
Security Context	0x0408	3.11.1.8
Confidentiality	0x0409	3.11.1.9
Termination	0x040A	3.11.1.10
Abort Cause	0x040B	3.11.1.11
Report Cause	0x040C	3.11.1.12
Abort Reason	0x040D	3.11.1.13
Components	0x040E	3.11.1.14
Component	0x040F	3.11.1.15
Transaction Id	0x0410	3.11.1.16

Parameters used in CH Messages

Parameter Name	Parameter ID	Section
Invoke Id	0x0411	3.11.2.1
Linked Id	0x0412	3.11.2.2
Component Flags	0x0413	3.11.2.3
Operation	0x0414	3.11.2.4
Parameters	0x0415	3.11.2.5
Error	0x0416	3.11.2.6
Problem Code	0x0417	3.11.2.7
Timeout	0x0418	3.11.2.8

Other Parameters

Parameter Name	Parameter ID	Section
Subsystem Number	0x0419	3.11.3.1
Subsystem Multiplicity Indicator	0x041A	3.11.3.2
Congestion Level	0x041B	3.11.3.3
User/Cause	0x041C	3.11.3.4
Network Appearance	0x041D	3.11.3.5
Routing Key	0x041E	3.11.3.6
Address Range	0x041F	3.11.3.7
Destination Transaction Id	0x0420	3.11.3.8
Originating Transaction Id	0x0421	3.11.3.9
Transaction Id Range	0x0422	3.11.3.10
Global Title	0x0423	3.11.3.11
Point Code	0x0424	3.11.3.12

3.11.1. Parameters used in DH Messages**3.11.1.1. Dialogue Id**

The *Dialogue Id* parameter is used in the TUA Message Header to identify the dialogue within the Application Server indicated by the Routing Context (also in the TUA Message Header).

The *Dialogue Id* parameter is formatted as follows:

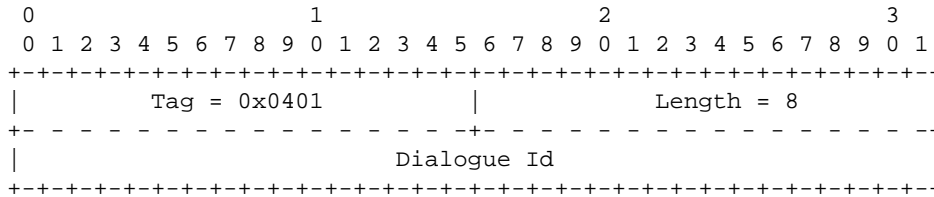

The *Dialogue Id* parameter contains the following fields:

Dialogue Id field: 32-bits (unsigned integer)

The *Dialogue Id* field contains an identifier that is used both at the SG and the ASP to identify a dialogue within an Application Server. The Dialogue Id value must be unique within the scope of a given Application Server and Routing Context.

For a given AS and Routing Context, either the SG or the ASP is responsible for assigning Dialogue Ids, but not both.

3.11.1.2. Dialogue Flags

The *Dialogue Flags* parameter is used in the DH Message Header and is used to indicate whether components are present (when the message is sent from SG to ASP) and whether permission is granted for the receiving TC-User to terminate the dialogue.

The *Dialogue Flags* parameter is formatted as follows:

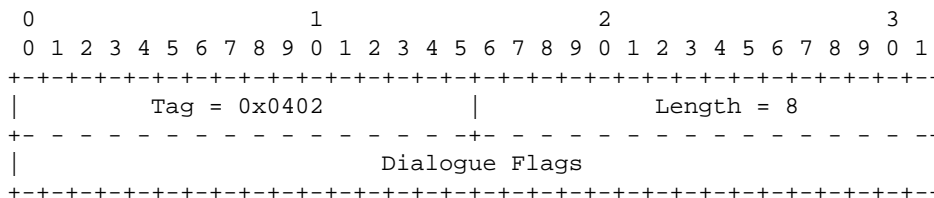

The *Dialogue Flags* parameter contains the following fields:

Dialogue Flags field: 32-bits (bit field)

The Dialogue Flags field contains flag bits used in to indicate additional characteristics of the DH message. The Dialogue Flags field is formatted as follows:

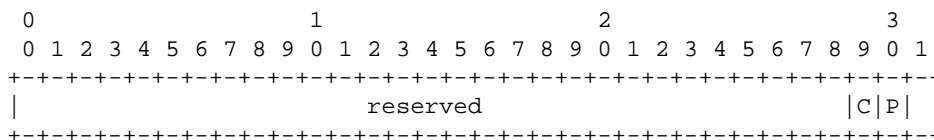

Bits 0-28: Reserved (coded zero)

Reserved bits are reserved for later IETF extensions and are coded zero.

Bit 29: Components Present

The *Components Present* bit is set in the indication (i.e, sent from SG to ASP) forms of Dialogue Handling (DH) messages to indicate that Component Handling (CH) messages will follow containing the components associated with the Dialogue Handling message.

Bit 20: Permission

The *Permission* bit is cleared in Dialogue Handling (DH) messages to indicate that the remote TC-User is not permitted to end the dialogue.

Bit 31: Reserved (coded zero)

Reserved bits are reserved for later IETF extensions and are coded zero.

3.11.1.3. Quality of Service

The *Quality of Service* parameter contains the QoS parameters for the underlying SCCP Network Service.

The *Quality of Service* parameter is formatted as follows:

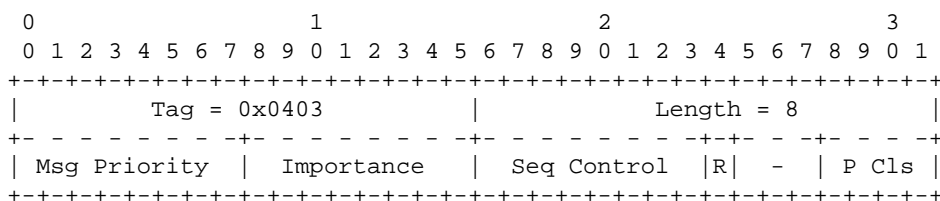

The *Quality of Service* parameter contains the following fields:

Protocol Class field: 4-bits (unsigned integer)

The Protocol Class field indicates the SCCP Protocol Class requested by the TC-User for the current Dialogue Handling message. Valid values for the Protocol Class field are as follows:

- 0 SCCP Protocol Class 0 TCAP Operation Class 4
- 1 SCCP Protocol Class 1 TCAP Operation Class 1, 2, and 3
- 2 SCCP Protocol Class 2 TCAP Operation Class 1, 2, and 3
- 3 SCCP Protocol Class 3 TCAP Operation Class 1, 2, and 3

Spare field: 3-bits (coded zero)

Spare bits are coded zero.

Return Option field: 1-bit (boolean)

Specifies whether the SCCP "return message on error" is requested when the Protocol Class field is set to SCCP Protocol Class 0 or 1. When the Protocol Class field is set to SCCP Protocol Class 2 or 3, this field **MAY** be ignored by the SG. The Return Option field has the following values:

- 0 No "Return On Error" option requested.
- 1 "Return On Error" option requested.

Sequence Control field: 8-bits (unsigned integer)

When the Protocol Class field is other than SCCP Protocol Class 0, the *Sequence Control* field provides a sequence control parameter which is used by the underlying SS7 SCCP and MTP layer at the SG to generate an SLS value. When the Protocol Class field is set to Protocol Class 0, this field **SHOULD** be coded to zero and **MUST** be ignored by the SG.

Importance field: 8-bits (unsigned integer)

The Importance field contains the SCCP Importance level requested by the TC-User. Where the underlying SCCP transport at an SG does not support SCCP flow control [Q.714], this field **SHOULD** be coded to zero and **MUST** be ignored by the SG [4]. Valid values for the Importance field are as follows:

- 0 SCCP Importance Level 0 or Unspecified
- 1 SCCP Importance Level 1
- 2 SCCP Importance Level 2
- 3 SCCP Importance Level 3
- 4 SCCP Importance Level 4
- 5 SCCP Importance Level 5
- 6 SCCP Importance Level 6
- 7 SCCP Importance Level 7

Message Priority field: 8-bits (unsigned integer)

The Message Priority field contains the MTP Message Priority requested when the underlying SS7 transport at an SG supports multiple congestion levels [Q.704]. When the underlying transport does not support multiplex congestion levels or states, this field **SHOULD** be coded to zero and **MUST** be ignored by the SG [5]. Valid values for the Message Priority field are as follows:

- 0 Message Priority 0 or Unspecified
- 1 Message Priority 1
- 2 Message Priority 2
- 3 Message Priority 3

3.11.1.4. Destination Address

The *Destination Address* parameter is formatted as follows:

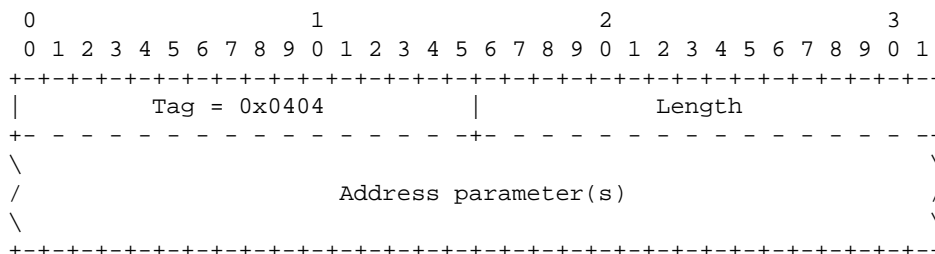

The *Destination Address* parameter contains the following fields:

Address field: variable length (address parameter list)

The *Address* field contains a list of one or more address parameters. At least one address parameter **MUST** be present in the Address field. The *Address* field can contain the following parameters:

Parameters		
<i>Point Code</i>	Conditional	*1
<i>Subsystem Number</i>	Conditional	*1
<i>Global Title</i>	Optional	

Note :1 When the Address field contains a *Subsystem Number* parameter, it must also contain a *Point Code* parameter.

3.11.1.5. Originating Address

The *Originating Address* parameter is formatted as follows:

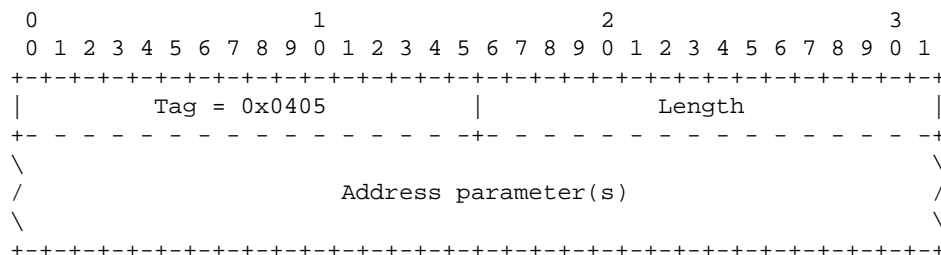

The *Originating Address* parameter contains the following fields:

Address field: variable length (address parameter list)

The *Address* field contains a list of one or more address parameters. At least one address parameter **MUST** be present in the Address field. The *Address* field can contain the following parameters:

Parameters		
<i>Point Code</i>	Conditional	*1
<i>Subsystem Number</i>	Conditional	*1
<i>Global Title</i>	Optional	

Note :1 When the Address field contains a *Subsystem Number* parameter, it must also contain a *Point Code* parameter.

3.11.1.6. Application Context Name

The *Application Context Name* parameter contains the identifier of the application context proposed by the dialogue initiator or by the dialogue responder. An application context is an explicitly identified set of application-service-elements, related options and any other necessary information for the interworking of application-entities on a dialogue.

For a description of the Application Context Name parameter, see the ITU [Q.771] TCAP specifications.

The *Application Context Name* parameter is formatted as follows:

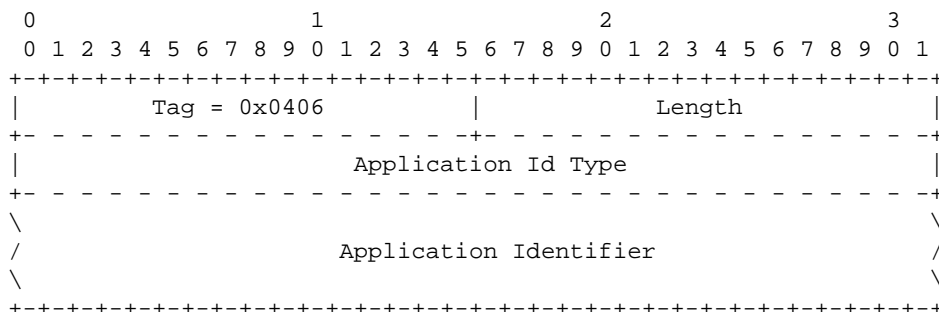

The *Application Context Name* parameter contains the following fields:

Application Id Type field: 32-bits (unsigned integer)

The *Application Id Type* field indicates the type of Application Identifier that is present in the Application Identifier field. Valid values for the Application Id Type are as follows:

- 0 ASN.1 OBJECT IDENTIFIER
- 1 ASN.1 INTEGER

Application Identifier field: variable length (bytes)

The *Application Identifier* contains an identifier of the application context that is being proposed by the dialogue initiator or responder. When the Application Type is ‘0’ this field **MUST** be formatted as an **OBJECT IDENTIFIER** [X.680] representing the proposed Application Id. When the Application Type is ‘1’ this field **MUST** be formatted as 32-bit unsigned integer value representing the proposed Application Id.

3.11.1.7. User Information

The *User Information* parameter contains information which can be exchanged between TC-Users independently from the Remote Operation Service.

For a description of the User Information parameter, see the ITU [Q.771] TCAP specifications.

The *User Information* parameter is formatted as follows:

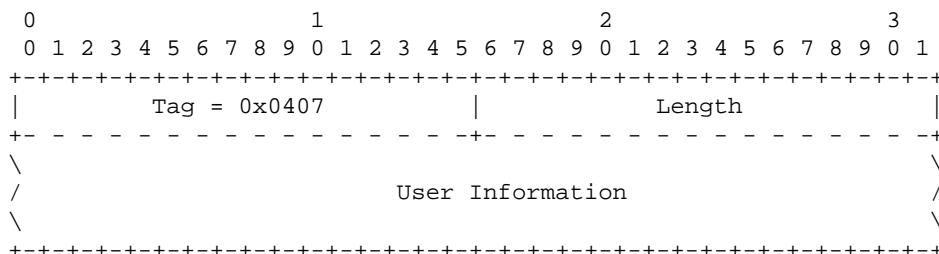

The *User Information* parameter can contain the following fields:

User Information field: variable length (bytes)

The internal format of the *User Information* field is opaque to TUA and to TCAP. The contents of this field is a string of bytes as they were provided to the TUA layer by the TC-User in a TC-BEGIN, TC-CONT, or TC-END primitive.

3.11.1.8. Security Context

The *Security Context* parameter contains the identifier of the security context proposed by the dialogue initiator or by the dialogue responder.

The *Security Context* parameter is formatted as follows:

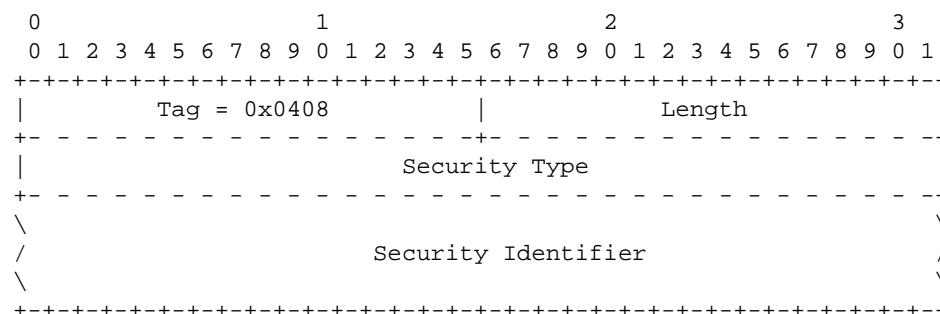

The *Security Context* parameter contains the following fields:

Security Id Type field: 32-bits (unsigned integer)

The *Security Id Type* field indicates the type of Security Identifier that is present in the Security Identifier field. Valid values for the Security Id Type are as follows:

- 0 ASN.1 OBJECT IDENTIFIER
- 1 ASN.1 INTEGER

Security Identifier field: variable length (bytes)

The *Security Identifier* contains an identifier of the application context that is being proposed by the dialogue initiator or responder. When the Security Type is '0' this field **MUST** be formatted as an **OBJECT IDENTIFIER** [X.680] representing the proposed Security Id. When the Security Type is '1' this field **MUST** be formatted as 32-bit unsigned integer value representing the proposed Security Id.

3.11.1.9. Confidentiality

Confidentiality Identifier is coded context specific (in the context of the dialogue portion sequence), constructor.

The *Confidentiality* parameter is formatted as follows:

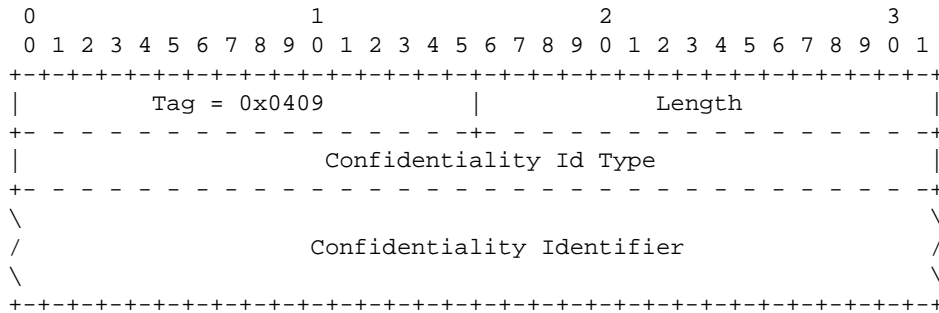

The *Confidentiality* parameter contains the following fields:

Confidentiality Id Type field: 32-bits (unsigned integer)

The *Confidentiality Id Type* field indicates the type of Confidentiality Identifier that is present in the Confidentiality Identifier field. Valid values for the Confidentiality Id Type are as follows:

- 0 ASN.1 OBJECT IDENTIFIER
- 1 ASN.1 INTEGER

Confidentiality Identifier field: variable length (bytes)

The *Confidentiality Identifier* contains an identifier of the application context that is being proposed by the dialogue initiator or responder. When the Confidentiality Type is ‘0,’ this field **MUST** be formatted as an **OBJECT IDENTIFIER** [X.680] representing the proposed Confidentiality Id. When the Confidentiality Type is ‘1,’ this field **MUST** be formatted as 32-bit unsigned integer value representing the proposed Confidentiality Id.

3.11.1.10. Termination

The *Termination* parameter indicates the dialogue termination scenario chosen by the TC-User (prearranged or basic).

The *Termination* parameter is formatted as follows:

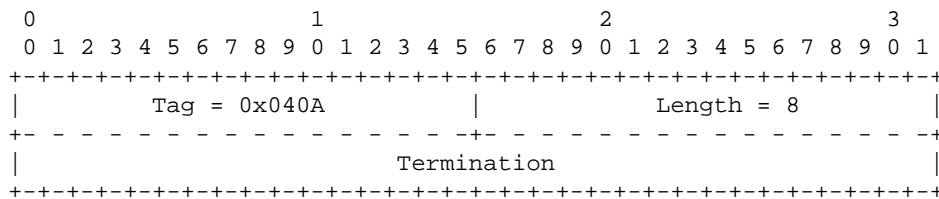

The *Termination* parameter contains the following fields:

Termination field: 32-bit (unsigned integer)

The *Termination* field indicates the dialogue termination scenario chosen by the TC-User and can have one of the following values:

- 0 Prearranged
- 1 Basic

3.11.1.11. Abort Cause

The *Abort Cause* parameter is included in the *TUAB*, *TPAB*, *TUAB* and *TPAB* messages and indicates the reason for aborting the transaction or dialogue.

The *Abort Cause* parameter is formatted as follows:

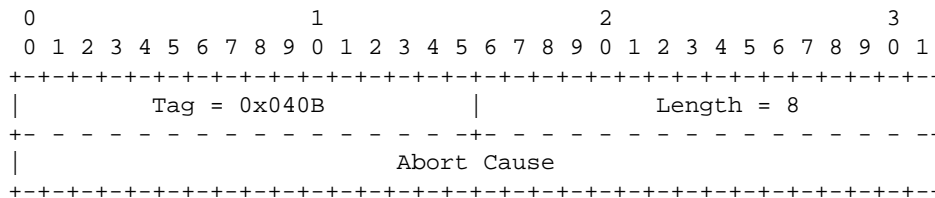

The *Abort Cause* parameter contains the following fields:

Abort Cause field: 32-bit (unsigned integer)

The *Abort Cause* field indicates the reason for aborting the dialogue and has a TCAP protocol-variant-specific value. Example values for ITU [Q.773] and ANSI [T1.114] are as follows:

	ITU-T Description	ANSI Description
0	unrecognized message type	–
1	unrecognized transaction id	unrecognized package type
2	badly formatted transaction portion	incorrect transaction portion
3	incorrect transaction portion	badly structured transaction portion
4	resource limitation	unassigned responding transaction identifier
5	L_RESOURCE_LIMIT	permission to release problem
6	invalid dialogue request	resource unavailable
7	pending expired	unrecognized dialogue portion identifier
8	begin expired	badly structured dialogue portion
9	inactive expired	missing dialogue portion
10	destination address unknown	inconsistent dialog portion
11	network error	–
12	unrecognized dialogue identifier	–
13	abnormal dialogue portion	–
14	no common dialogue portion	–

3.11.1.12. Report Cause

The *Report Cause* parameter indicates the reason for the sending of an *TNOT* message and reflects the SCCP reason that would be used for returning a TCAP message.

The *Report Cause* parameter is formatted as follows:

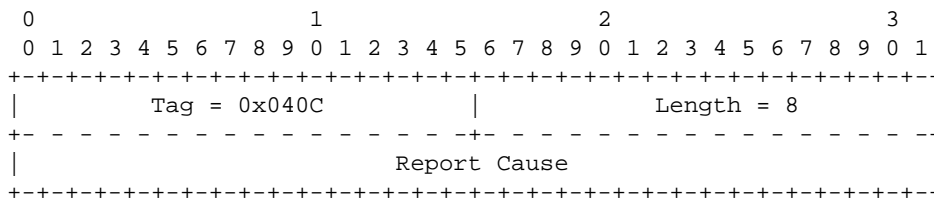

The *Report Cause* parameter contains the following fields:

Report Cause field: 32-bit (unsigned integer)

The *Report Cause* field indicates the reason that a TC-User message could not be delivered and has the following values:

- 0 no translation for an address of such nature
- 1 no translation for this specific address
- 2 subsystem congestion
- 3 subsystem failure
- 4 unequipped user
- 5 MTP failure
- 6 network congestion
- 7 SCCP unqualified
- 8 error in message transport
- 9 error in local processing
- 10 destination cannot perform re-assembly
- 11 SCCP failure
- 12 hop counter violation
- 13 segmentation not supported
- 14 segmentation failed.

3.11.1.13. Abort Reason

The *Abort Reason* parameter indicates whether a dialogue is aborted because the received application context name is not supported and no alternative one can be proposed or because of any other user problem.

The *Abort Reason* parameter is formatted as follows:

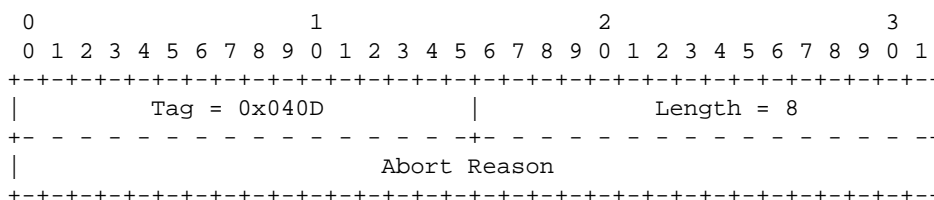

The *Abort Reason* parameter contains the following fields:

Abort Reason field: 32-bits (unsigned integer)

The *Abort Reason* field indicates whether the dialogue was aborted because the received application context name is not supported and no alternative can be proposed or because of any other user problem. The valid values for *Abort Reason* are as follows:

- 0 application context not supported
- 1 user specific

3.11.1.14. Components

The *Components* parameter is used to attach components directly to a TUA Dialogue Handling (DH) message instead of in separate Component Handling (CH) messages.

The *Components* parameter is formatted as follows:

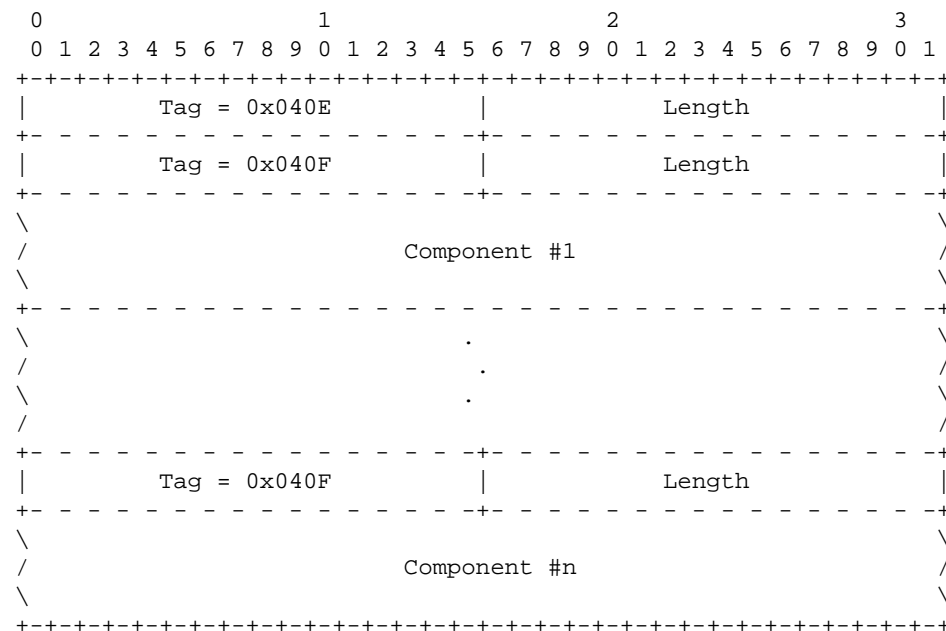

The *Components* parameter contains the following parameters:

Parameters		
<i>Component</i>	Conditional	*1

Note 1: The *Components* parameter **MUST** contain at least one *Component* parameter, but may contain more than one *Component* parameter.

3.11.1.15. Component

The *Component Type* field identifies the type of component (CINV, CRES, CCAN, etc.) that is contained within a *Component* parameter.

The *Component Type* parameter is formatted as follows:

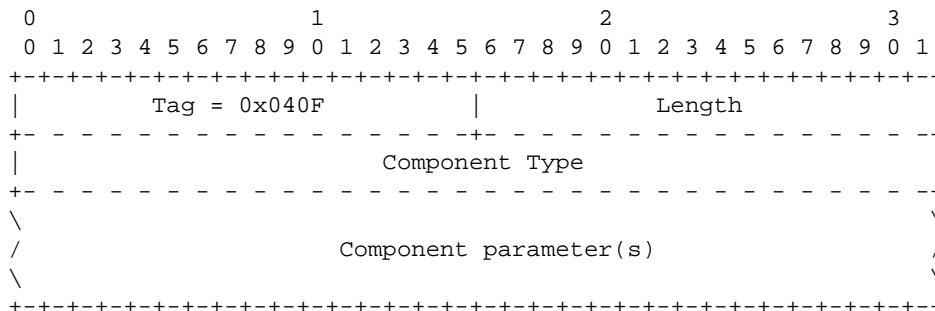

The *Component Type* parameter contains the following fields:

Component Type field: 32-bit (unsigned integer)

The *Component Type* field indicates the type of component contained in the component parameter. It can take on the following values: (Note that not all values are supported for interworking with all TCAP protocol variants.)

- 0 Invoke Last
- 1 Invoke Not Last
- 2 Result Last
- 3 Result Not Last
- 4 Error
- 5 Reject (User)
- 6 Reject (Local)
- 7 Reject (Remote)
- 8 Cancel

Component field: variable length (TLV parameter list)

The *Component* field contains the parameters associated with the component. This field may contains the following components, however, the formatting of the Component field **MUST** be the same as for the corresponding TUA message as follows:

Component Type	CH Msg	Section
0 Invoke Last	CINV	3.4.2
1 Invoke Not Last		
2 Result Last	CRES	3.4.3
3 Result Not Last		
4 Error	CERR	3.4.4
5 Reject (User)	CREJ	3.4.5
6 Reject (Local)		
7 Reject (Remote)		
8 Cancel	CCAN	3.4.6

3.11.1.16. Transaction Id

The *Transaction Id* parameter is formatted as follows:

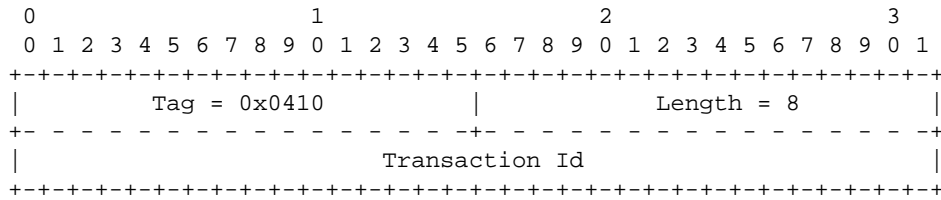

The *Transaction Id* parameter contains the following fields:

Transaction Id field: 32-bits (unsigned integer)

The *Transaction Id* field contains the value of the originating or terminating transaction identifier.

3.11.2. Parameters used in CH Messages

3.11.2.1. Invoke Id

The *Invoke Id* parameter identifies an invoke component. This identifier is only significant within the scope of a transaction and need only uniquely identify a dialogue within a transaction in a given direction (e.g, from SGP to ASP). The value of the *Invoke Id* parameter is chosen by the TUA peer sending the Invoke. As both the ASP and SGP could be assigning the same values of *Invoke Id* to invocations in each direction, the *Invoke Id* need only be unique in one direction.

The *Invoke Id* parameter is formatted as follows:

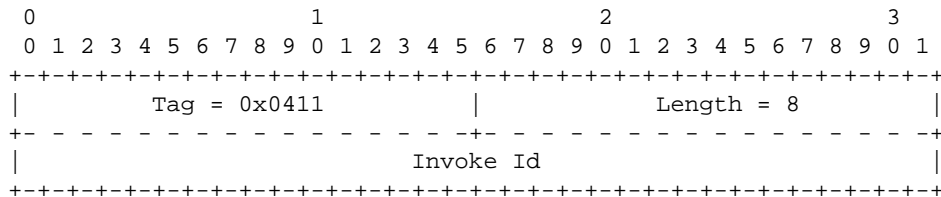

The *Invoke Id* parameter contains the following fields:

Invoke Id field: 32-bit (unsigned integer)

The *Invoke Id* field contains the value of the invoke identifier for the current component.

3.11.2.2. Linked Id

The *Linked Id* parameter is formatted as follows:

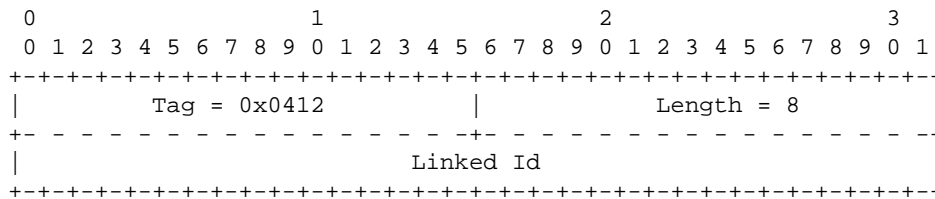

The *Linked Id* parameter contains the following fields:

Linked Id field: 32-bit (unsigned integer)

The *Linked Id* field contains the value of the linked or correlation invoke identifier which is related to the current component.

3.11.2.3. Component Flags

The *Component Flags* parameter is used in the *CINV* and *CRES* CH messages to indicate whether the contained components are segmented and whether they represent the last segment in a sequence of component segments.

The *Component Flags* parameter is formatted as follows:

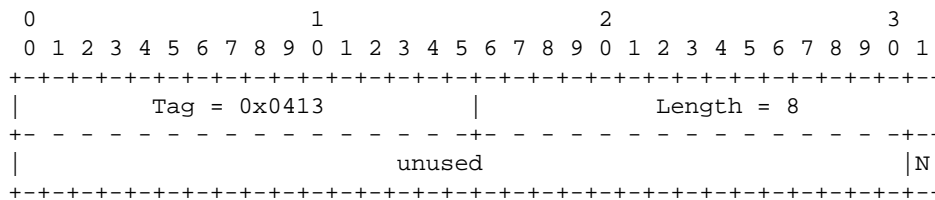

The *Component Flags* parameter contains the following fields:

Component Flags field: 32-bits

The Component Flags field is used to convey information about the components in a Component Handling (CH) message. It contains the following bit fields:

Bits 0-30: Unused

These bits are reserved and are coded to zero.

Bit 31: Not Last Bit

The Not Last bit is used to indicate whether the component present in the CH message is the last component of a sequence of segmented components. It has the following values:

- 0 Last component in a component sequence.
- 1 Not the last component in a component sequence.

To smoothly interwork with TCAP, TUA includes a mechanism whereby components can be segmented: the CH message with the "Not Last" bit set in the Component Flags field provides for the initial segments of a

segmented component, whereas the CH message with the "Not Last" bit clear in the Component Flags field provides for the final (or only) segment in a sequence of component segments representing the complete component. When interworking with TCAP, each component segment may be sent in a different TCAP package [Q.775].

3.11.2.4. Operation

The *Operation* parameter is formatted as follows:

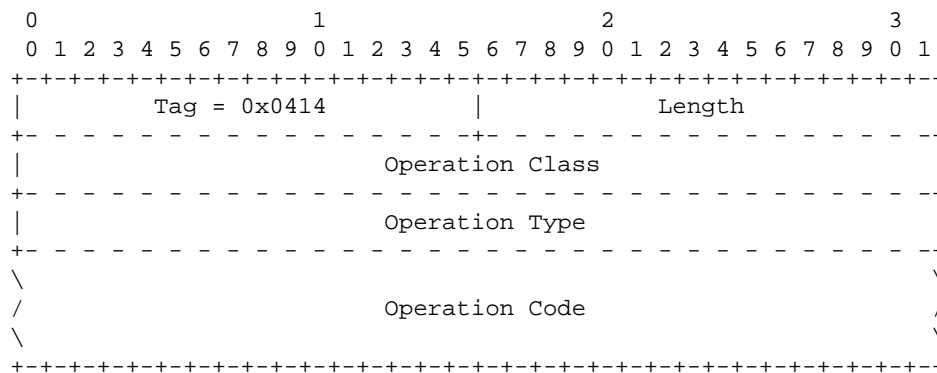

The *Operation* parameter contains the following fields:

Operation Class field: 32-bit (unsigned integer)

The *Operation Class* field indicates the operational class of the invoke in which it appears and has the following values:

- 0 not specified
- 1 Class 1 both success and failure are reported
- 2 Class 2 only failure is reported
- 3 Class 3 only success is reported
- 4 Class 4 neither success, nor failure is reported

Operation Type field: 32-bit (unsigned integer)

The *Operation Type* field indicates the type of operation code and has the following values:

- 1 National TCAP Operation INTEGER
- 2 Private TCAP Operation INTEGER
- 3 Local TCAP Operation INTEGER
- 4 Global TCAP Operation OBJECT IDENTIFIER

Operation Code field: variable length (based on type)

The *Operation Code* field contains an identifier of the requested operation. When the Operation Type is "National," "Private," or "Local," this field **MUST** be formatted as 32-bit unsigned integer value representing the requested operation. When the Operation Type is "Global," this field **MUST** be formatted as an **OBJECT IDENTIFIER** [X.680], representing the requested operation. The value of this field is TCAP protocol-

variant-specific.

3.11.2.5. Parameters

The *Parameters* parameter identifies the parameter set or parameter sequence that accompanies an operation invocation or response.

The *Parameters* parameter is formatted as follows:

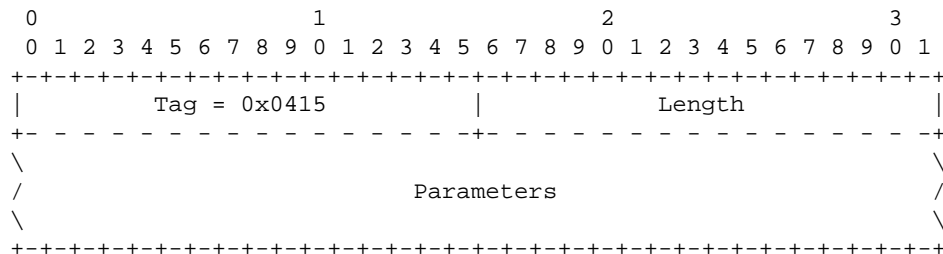

The *Parameters* parameter contains the following fields:

Parameters field: variable length (bytes)

The *Parameters* field contains all of the parameters coded according to the coding [X.680] for Parameter Sequences or Parameter Sets per the applicable TCAP protocol specification. For example, ITU [Q.773] or ANSI [T1.114]. [6]

3.11.2.6. Error

The *Error* parameter is formatted as follows:

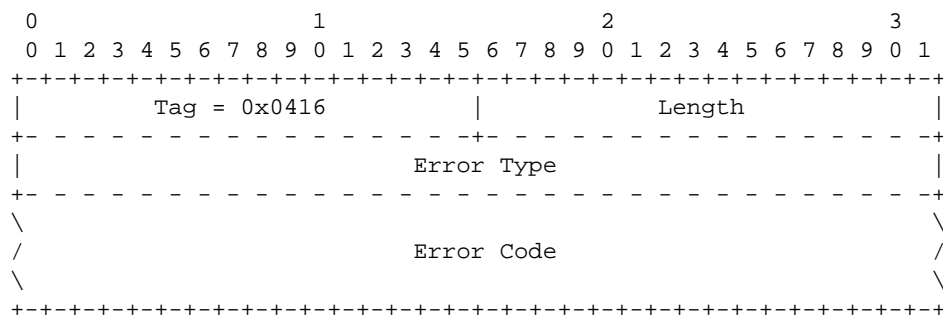

The *Error* parameter contains the following fields:

Error Type field: 32-bit (unsigned integer)

The *Error Type* field indicates the level (i.e, local or global) at which the error was generated. It has the following values:

- 1 National TCAP Error INTEGER
- 2 Private TCAP Error INTEGER

- 3 Local TCAP Error INTEGER
- 4 Global TCAP Error OBJECT IDENTIFIER

Error Code field: variable length (based on type)

The *Error Code* field contains an identifier of the indicated error. When the Error Type is "National," "Private," or "Local," this field **MUST** be formatted as a 32-bit signed integer value representing the indicated error. When the Error Type is "Global," this field **MUST** be formatted as an **OBJECT IDENTIFIER** [X.680] representing the indicated error. The value of this field is TCAP protocol-variant-specific.

3.11.2.7. Problem Code

The *Problem Code* parameters identifies the reason for rejecting a component. The *Problem Code* parameters is formatted as follows:

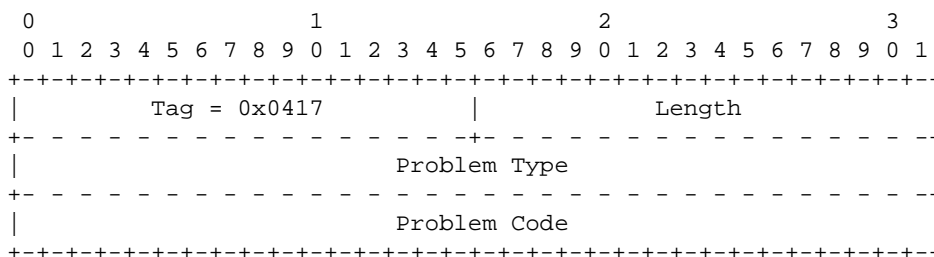

The *Problem Code* parameters contains the following fields:

Problem Type field: 32-bit (unsigned integer)

The *Problem Type* field indicates the reason for rejecting a component and has the following values: (Note that not all problem type field values are applicable to all TCAP protocol variants.)

- 0 General Problem
- 1 Problem with Invoke
- 2 Problem with Return Result
- 3 Problem with Return Error
- 4 Problem with Transaction Portion (deprecated)

Problem Code field: variable length (signed integer)

The *Problem Code* field indicates the specific problem associated with the Problem Type. For more information on problem codes, see Q.773 Chapter 4.2.2.6 and ANSI T1.114.3 Chapter 5.16.2.

Problem Code field: 32-bit (signed integer)

The *Problem Code* field indicates the specific problem associated with the Problem Type. This is a TCAP protocol-variant-specific value. Following are some example values for ITU [Q.773] and ANSI [T1.114]:

	ITU	ANSI
General	0 unrecognized component	–
Problem	1 mis-typed component	unrecognized component type
	2 badly structured component	incorrect component portion
	3 –	badly structured component portion
Invoke	0 duplicate invoke id	–
Problem	1 unrecognized operation	duplicate invocation
	2 mis-typed parameter	unrecognized operation
	3 resource limitation	incorrect parameter
	4 initiating release	unrecognized correlation id
	5 unrecognized linked id	–
	6 linked response unexpected	–
	7 unexpected linked operation	–
Return	0 unrecognized invoke id	–
Result	1 return result unexpected	unrecognized correlation id
Problem	2 mis-typed parameter	unexpected return result
	2 –	incorrect parameter
Return	0 unrecognized invoke id	–
Error	1 return error unexpected	unexpected return error
Problem	2 unrecognized error	unrecognized error
	3 unexpected error	unexpected error
	4 mis-typed parameter	incorrect parameter
	Trans	1 –
Portion	2 –	incorrect transaction portion
Problem (depr.)	3 –	badly structured transaction portion
	4 –	unassigned responding transaction id
	5 –	permission to release problem
	6 –	resource unavailable

3.11.2.8. Timeout

The *Timeout* parameter is formatted as follows:

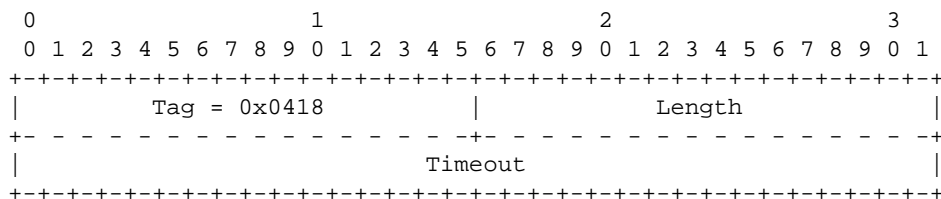

The *Timeout* parameter contains the following fields:

Timeout field: 32-bit (unsigned integer)

The *Timeout* field contains the timeout value in seconds that the sender will wait before an invocation is canceled.

3.11.3. Other Parameters

3.11.3.1. Subsystem Number

The *Subsystem Number* parameter is formatted as follows:

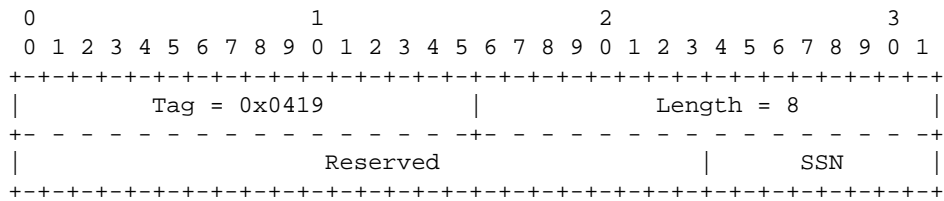

The *Subsystem Number* parameter contains the following fields:

Reserved field: 24-bits (coded zero)

Reserved bits are coded zero.

SSN field: 8-bits (unsigned integer)

The *SSN* field contains the SCCP subsystem number [T1.112, Q.713].

3.11.3.2. Subsystem Multiplicity Indicator

The *Subsystem Multiplicity Indicator* is formatted as follows:

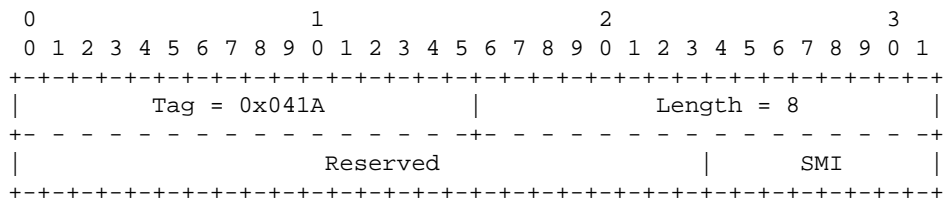

The *Subsystem Multiplicity Indicator* contains the following fields:

Reserved field: 24-bits (coded zero)

Reserved bits are coded zero.

SMI field: 8-bits (unsigned integer)

The *SMI* field contains the SCCP subsystem multiplicity indicator. Valid values for the *SMI* field are as follows:

- 0 Reserved/Unknown
- 1 Solitary
- 2 Duplicated
- 3 Triplicated

- 4 Quadruplicated
-
- 255 Unspecified

3.11.3.3. Congestion Level

The *Congestion Level* parameter is used to indicate the MTP network congestion level or SCCP restricted importance level and is used in the *Network Congestion (SCON)* message.

The *Congestion Level* parameter is formatted as follows:

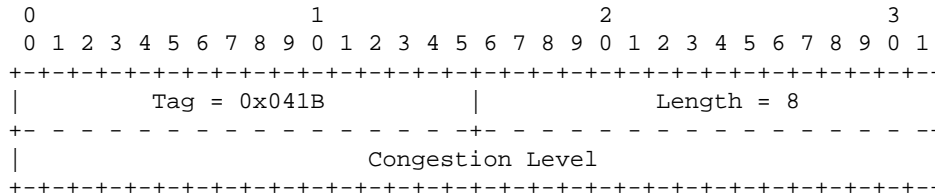

The *Congestion Level* parameter contains the following fields:

Congestion Level field: 32-bits (unsigned integer)

The Congestion Level field contains the level at which congestion has occurred.

When the Congestion Level parameter is included in a *SCON* message that corresponds to an N-PCSTATE request indication primitive, the Congestion Level field indicates the MTP congestion level experienced by the local or affected signalling point as indicated by the Affected Point Code(s) also in the *SCON* message. In this case, valid values for the Congestion Level field are as follows:

- 0 No Congestion or Undefined
- 1 Congestion Level 1
- 2 Congestion Level 2
- 3 Congestion Level 3

When the Congestion Level parameter is included in a *SCON* message that corresponds to an N-STATE request or indication primitive, the Congestion Level field indicates the SCCP restricted importance level experienced by the local or affected subsystem as indicated by the Affected Point Code and Subsystem Number also in the *SCON* message. In this case, valid values for the Congestion Level field range from 0 to 7, where 0 indicates the least congested and 7 indicates the most congested subsystem.

3.11.3.4. User/Cause

The *User/Cause* parameter is used to report the affected user and the cause of the unavailability of the user in a *DUPU* message.

The *User/Cause* parameter is formatted as follows:

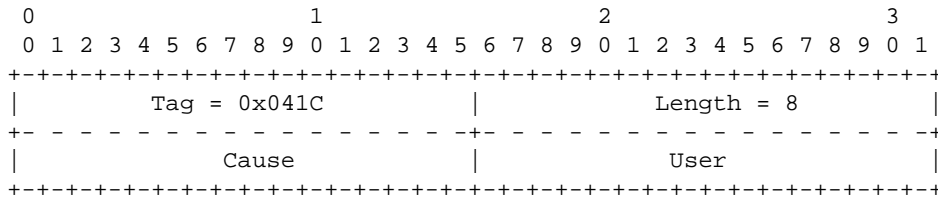

The *User/Cause* parameter contains the following fields:

Cause field: 16-bits (unsigned integer)

The *Cause* field indicates the cause of the unavailability of the remote user. Valid *Cause* values are as follows:

- 0 Unknown
- 1 Unequipped Remote User
- 2 Inaccessible Remote User

User field: 16-bits (unsigned integer)

The *User* field contains the SI value of the MTP User [Q.704] that is being reported unavailable. For TUA, this is the SI value of the SCCP (normally SI = 3). The TC-User **MAY** ignore the *User* field.

3.11.3.5. Network Appearance

The *Network Appearance* parameter is used as a parameter in the *Registration Request (REG REQ)* message to indicate the network context in which the remainder of the Routing Key parameters are to be interpreted. The *Network Appearance* parameter is also used in the *Error (ERR)* message in response to a *REG REQ* message when a received Network Appearance parameter contains an invalid value.

The *Network Appearance* parameter is formatted as follows:

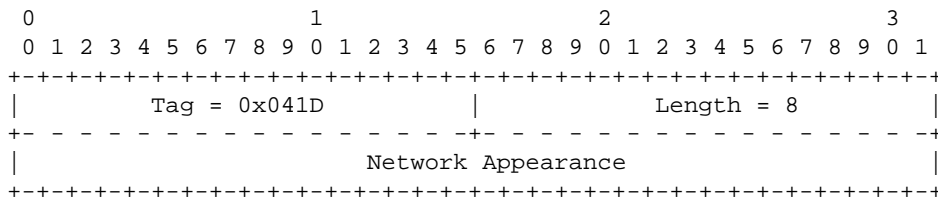

The *Network Appearance* parameter can contain the following fields:

Network Appearance field: 32-bits (unsigned integer)

The Network Appearance field identifies the SS7 network context for the Routing Key. The Network Appearance value is of local significance only, coordinated between the SG and ASP. Therefore, in the case where the ASP is connected to more than one SG, the same SS7 Network context may be identified by a different Network Appearance value depending upon to which SG the ASP is registering.

In the Routing Key, the Network Appearance identifies the SS7 Point Code and Global Title Transaction Type format used, and the SCCP, TCAP and TC-User protocol (type, variant and version) used within the specific SS7 network.

3.11.3.6. Routing Key

The *Routing Key* parameter is used in the *REG REQ* message to list and identify the Routing Keys that are being registered.

The *Routing Key* parameter is formatted as follows:

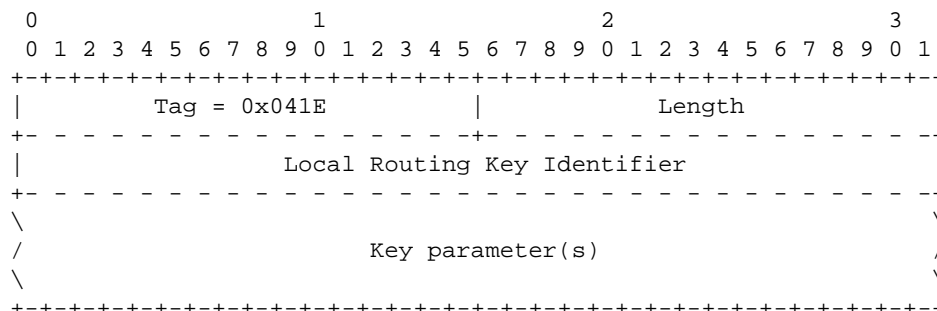

The *Routing Key* parameter can contain the following fields:

Local Routing Key Identifier field: 32-bits (unsigned integer)

The *Local Routing Key Identifier* field is used to uniquely identify the registration request. The identifier value is assigned by the ASP and is used to correlate the response in a *REG RSP* message with the original registration request. The identifier value must remain unique until the *REG RSP* (or *ERR*) message is received.

Key field: variable (TLV parameters)

The key field can contain the following parameters:

Parameters		
<i>Network Appearance</i>	Conditional	*1
<i>Traffic Mode Type</i>	Optional	
<i>Originating Address</i>	Optional	
<i>Destination Address</i>	Optional	
<i>Address Range</i>	Optional	
<i>Originating Transaction Id</i>	Optional	
<i>Destination Transaction Id</i>	Optional	
<i>Transaction Id Range</i>	Optional	
<i>Application Context Name</i>	Optional	
<i>User Information</i>	Optional	

Note 1: The Network Appearance parameter **MUST** be included in the Routing Key when the ASP is able to register in multiple SS7 Network contexts.

3.11.3.7. Address Range

The *Address Range* parameter is formatted as follows:

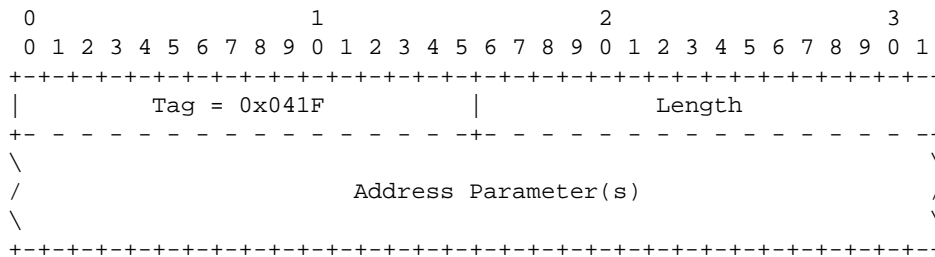

The *Address Range* parameter can contain the following fields:

Address field: variable (TLV parameters)

The *Address* field can contain the following parameters:

Parameters		
<i>Originating Address</i>	Conditional	*1
<i>Destination Address</i>	Conditional	*1

Note 1: The *Address* field must contain pairs of Originating Addresses or Destination Addresses and **MUST** contain one and only one pair of addresses; but, **MUST NOT** mix Originating Addresses with Destination Addresses in the same *Address* field.

3.11.3.8. Destination Transaction Id

The *Destination Transaction Id* parameter is formatted as follows:

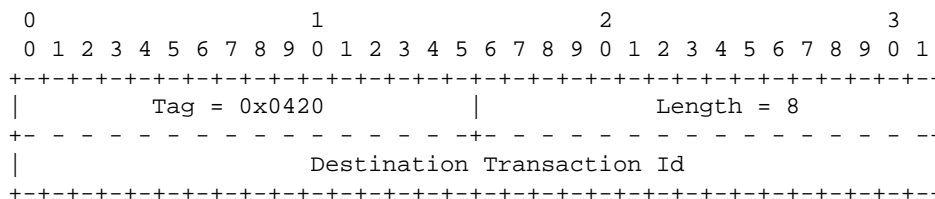

The *Destination Transaction Id* parameter can contain the following fields:

Destination Transaction Id field: 32-bits (unsigned integer)

The *Destination Transaction Id* field contains the Destination Transaction Identifier associated with the dialogue.

3.11.3.9. Originating Transaction Id

The *Originating Transaction Id* parameter is formatted as follows:

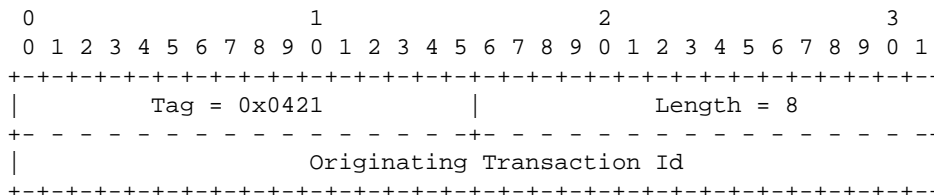

The *Originating Transaction Id* parameter can contain the following fields:

Originating Transaction Id field: 32-bits (unsigned integer)

The *Originating Transaction Id* field contains the Originating Transaction Identifier associated with the dialogue.

3.11.3.10. Transaction Id Range

The *Transaction Id Range* parameter is formatted as follows:

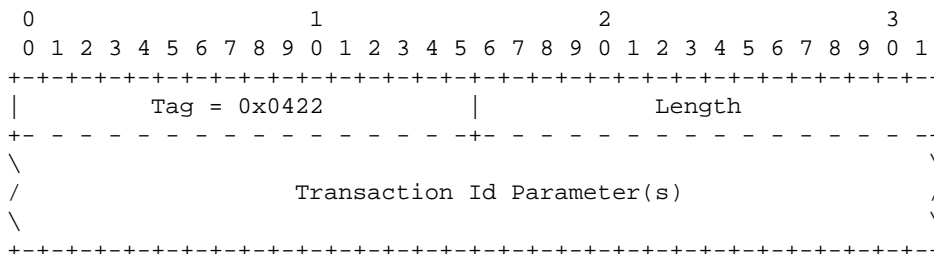

The *Transaction Id Range* parameter can contains the following fields:

Transaction Id field: list of 32-bit (unsigned integer)

The *Transaction Id* field can contain the following parameters:

Parameters		
<i>Originating Transaction Id</i>	Optional	*1
<i>Destination Transaction Id</i>	Optional	*1

Note 1: The Transaction Id field must contain pairs of Originating Transaction Ids or Destination Transaction Ids and **MUST** contain one and only one pair of Transaction Id parameters; but, **MUST NOT** mix Originating Transaction Ids with Destination Transaction Ids in the same Transaction Id field.

3.11.3.11. Global Title

The *Global Title* parameters is formatted as follows:

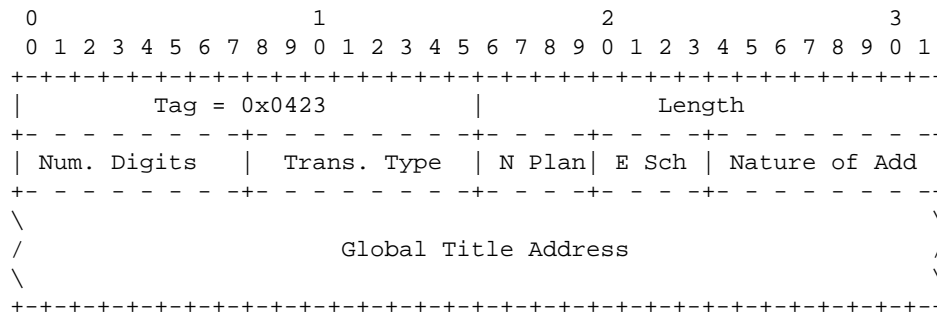

The *Global Title* parameters contains the following fields:

Number of Digits field: 8-bits (unsigned integer)

The *Number of Digits* field contains the number of address signals that are represented in the *Global Title Address* field.

Translation Type field: 8-bits (unsigned integer)

The *Translation Type* field contains the translation type to be performed on the address information in the *Global Title* parameter. This is a TCAP protocol-variant-specific value. Example valid values for ITU [Q.713] are as follows:

- 0 unknown
- 1 – 63 international services
- 128 – 254 national network specific

Numbering Plan field: 4-bits (unsigned integer)

The *Numbering Plan* field contains the numbering plan to which the address information contained in the *Global Title Address* field belongs. This is a TCAP protocol-variant-specific value. Example valid values for ITU [Q.713] are as follows:

- 0 unknown
- 1 ISDN/telephony numbering plan (E.163 and E.164)
- 2 generic numbering plan
- 3 data numbering plan (X.121)
- 4 telex numbering plan (F.69)
- 5 maritime mobile numbering plan (E.210, E.211)
- 6 land mobile numbering plan (E.212)
- 7 ISDN/mobile numbering plan (E.214)
- 14 private network or network-specific numbering plan

Encoding Scheme field: 4-bits (unsigned integer)

The *Encoding Scheme* field contains the format for the address information contained in the *Global Title Address* field. This is a TCAP protocol-variant-specific value. Example valid values for ITU [Q.713] are as follows:

- 0 unknown
- 1 BCD, odd number of digits
- 2 BCD, even number of digits
- 3 national specific

Nature of Address field: 8-bits (unsigned integer)

The *Nature of Address* field contains an indication of the nature of the information represented in the *Global Title Address* field. This is a TCAP protocol-variant-specific value. Example valid values for ITU [Q.713] are as follows:

- 0 unknown
- 1 subscriber number
- 2 reserved for national use
- 3 national significant number
- 4 international number

Global Title Address field: variable length (bytes)

The *Global Title Digits* field contains the global title address information. This information is formatted according to the Encoding Scheme, belongs to the Numbering Plan, has the Nature of Address, and contains the Number of Digits. When the encoding scheme is BCD, the Global Title Digits field is formatted as follows:

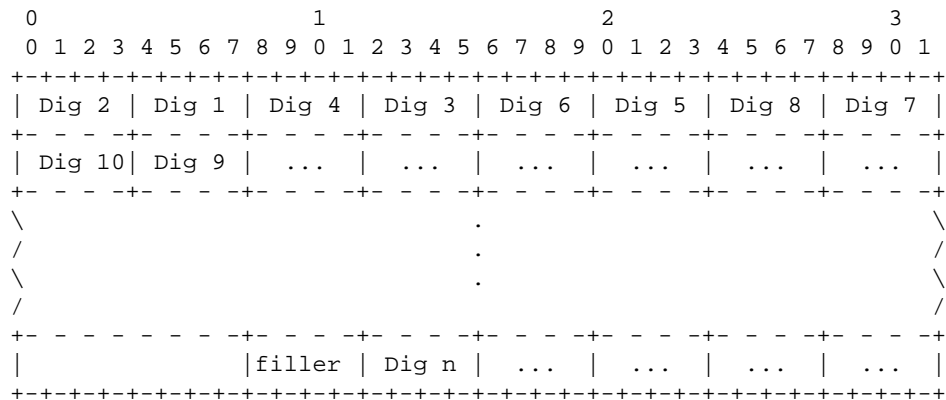

Where each digit is coded as follows:

- 0x0 digit 0
- 0x1 digit 1
- 0x2 digit 2
- 0x3 digit 3
- 0x4 digit 4
- 0x5 digit 5
- 0x6 digit 6
- 0x7 digit 7
- 0x8 digit 8
- 0x9 digit 9

- 0xA spare
- 0xB code 11
- 0xC code 12
- 0xD spare
- 0xE spare
- 0xF ST

When the Encoding Scheme is not "BCD," both the TUA layer at the ASP and the TUA layer at the SG should treat the Global Title Address as opaque.

3.11.3.12. Point Code

The *Point Code* parameters is formatted as follows:

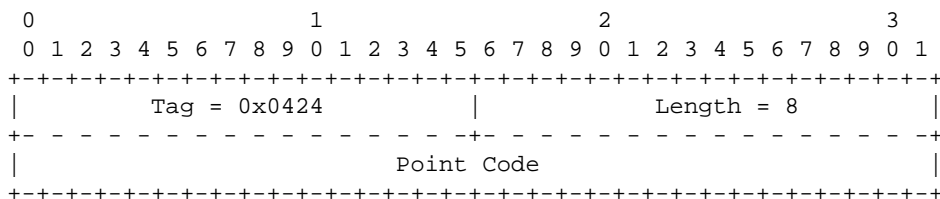

The *Point Code* parameters contains the following fields:

Point Code field: 32-bits (unsigned integer)

The *Point Code* field contains an SS7 signalling point code. Point codes that are less than 32-bits are padded on the left to the 32-bit boundary. The following examples show ANSI and ITU-T point codes:

ANSI 24-bit Point Code:

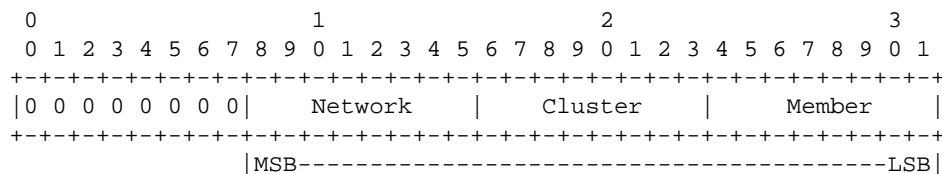

ITU-T 14-bit Point Code:

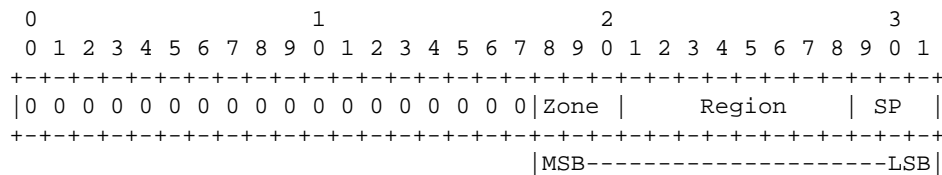

Notes for §3

- [1] **IMPLEMENTATION NOTE:**– The use of TLV in principle allows the parameters to be placed in a random order in the message. However, some guidelines should be considered for easy processing in the following order:
- parameters needed to correctly process other message parameters, preferably should precede these parameters (such as Routing Context).
 - Mandatory parameters preferably **SHOULD** precede any optional parameters.
 - The data parameter will normally be the final one in the message.
 - The receiver **SHOULD** accept parameters in any order, except where explicitly mandated.
- [2] **IMPLEMENTATION NOTE:**– An Application Server Process may be configured to process traffic for more than one logical Application Server. From the perspective of an ASP, a Routing Context defines a range of signalling traffic that the ASP is currently configured to receive from the SG.
- Additionally, the Routing Context parameter identifies the SS7 network context for the message, for the purposes of logically separating the signalling traffic between the SGP and the Application Server Process over a common SCTP Association, when needed. An example is where an SGP is logically partitioned to appear as an element in several different national SS7 networks. It implicitly defines the SS7 Point Code format used, the SS7 Network Indicator value and TCAP protocol type/variant/version used within a separate SS7 network. It also defines the network context for the PC and SSN values. Where an SGP operates in the context of a single SS7 network, or individual SCTP associations are dedicated to each SS7 network context, this functionality is not needed.
- [3] **IMPLEMENTATION NOTE:**– Correlation Id parameter can be used for features like Synchronization of ASPs and SGPs in a Broadcast Mode AS or SG; avoid message duplication and mis-sequencing in case of fail-over of association from one ASP or SGP to another ASP or SGP, etc.
- For application of the *Correlation Id* parameter see *CORID* [CORID].
- [4] **IMPLEMENTATION NOTE:**– The value in the Importance field in the Quality of Service parameter **MAY** be ignored or modified by a Signalling Gateway if the value contained is not consistent with SCCP flow control policy at the SG.
- [5] **IMPLEMENTATION NOTE:**– The value in the Message Priority field in the Quality of Service parameter **MAY** be ignored or modified by a Signalling Gateway if the value contained is not consistent with MTP congestion policy at the SG.

IMPLEMENTATION NOTE:– The Signalling Gateway **MAY**, at its option, segment the *Parameters* field into multiple parameters set to be send in multiple Invoke (Last/Not Last) or Return Result (Last/Not Last) components in separate TCAP packages to meet the maximum PDU requirements imposed by the underlying SCCP transport. Otherwise, if the Signalling Gateway finds that the resulting component is too large to fit into an SCCP UNITDATA message [Q.713], the SG **MAY**, at its option, return a *TNOT* message indicating to the TC-User that the component was too large.

4. Procedures

The TUA layer needs to respond to various local primitives it receives from other layers as well as the messages that it receives from the peer TUA layer. This section describes the TUA procedures in response to these events.

4.1. Procedures to Support the TC-User

4.1.1. Receipt of Primitives from the TC-User

Upon receiving a TC request or response primitive from the upper layer at an ASP or IPSP, the TUA layer sends a corresponding TUA Dialogue Handling (DH) or Component Handling (CH) message (see Section 3) to its TUA peer. The TUA peer receiving the DH or CH message delivers the corresponding TC primitive to the TC-User at the IPSP or Nodal Interworking Function at the SG as illustrated in *Figure 4*. The mapping of TC primitives to TUA DH Messages is listed in *Table 2*, and the CH Messages in *Table 3* (see Section 1.6.1).

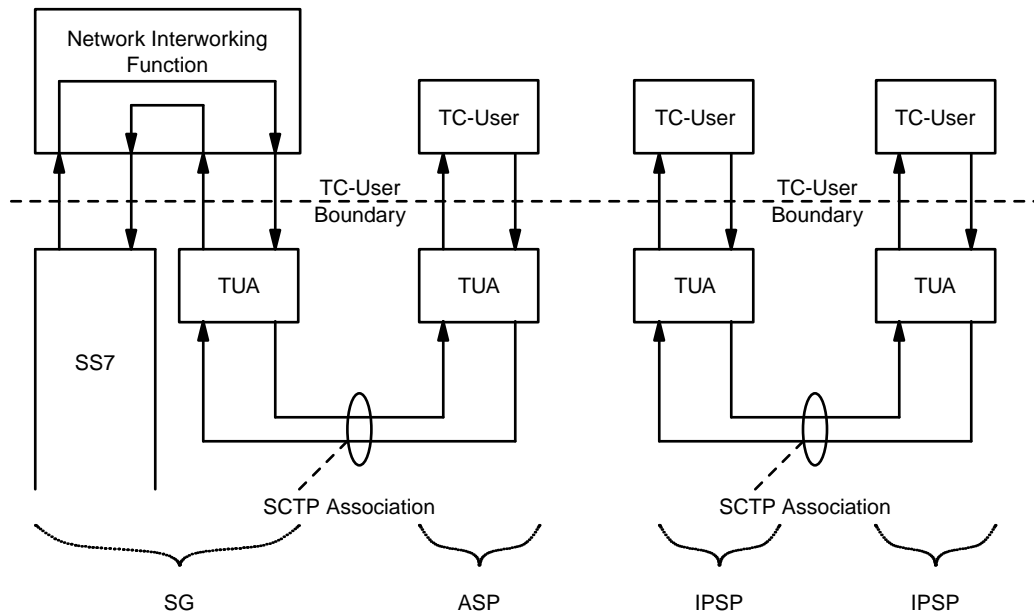

Figure 4. TUA Layer Model

4.1.2. Receipt of Primitives from TCAP

Upon receiving a TC indication or confirmation primitive from TCAP at an SG, the Nodal Interworking Function passes the primitive to TUA. The TUA layer sends a corresponding TUA Dialogue Handling (DH) or Component Handling (CH) message (see Section 3) to its TUA peer at the ASP.

The TUA peer receiving the DH or CH message delivers the corresponding TC primitive to the TC-User at the ASP as illustrated in *Figure 4*. The mapping of TC primitives to TUA DH Messages is listed in *Table 2*, and the CH Messages in *Table 3* (see Section 1.6.1).

The TUA Transaction Mapping Function (see Section)

For TC-BEGIN indications, the TUA Transaction Mapping Function (TMF) determines the Application Server (AS) based on comparing the address and dialogue portion information in the primitive with a provisioned Routing Key.

From the list of ASPs within an AS table, an ASP in the ASP-ACTIVE state is selected and a *TQRY* message is constructed and issued on the corresponding SCTP association. The TUA at the SG is also responsible for assigning and managing a Dialogue Identifier which is sent to the ASP in the *TQRY* message to identify the newly created dialogue to the ASP. Information associated with the dialogue is stored in the SG in an implementation

dependent manner; however, the SG must be capable of associating further TUA messages with the correct Dialogue at the SG. The SG will have to access this stored information to continue processing the dialogue.

The TUA Transaction Mapping Function (TMF) determines the Application Server (AS) based on comparing the information in the primitive with a provisioned Routing Key.

4.1.2.1. Receipt of Management Primitives from TCAP

When TCAP Management indications are received (N-STATE, N-PCSTATE, N-COORD), TCAP Management determines whether there are concerned local TC-Users. When these local TC-Users are in fact Application Servers, serviced by ASPs, TUA management is transparently informed with the N-STATE, N-PCSTATE, N-COORD indication primitive upon which it formats and transfers the applicable SSNM message (*DUNA*, *DAVA*, *DRST*, *DUPU* or *SCON*) to the list of concerned ASPs.

The TUA message distribution function determines the Application Server (AS) based on comparing the information in the TC-BEGIN, TC-CONTINUE, TC-END, or TC-ABORT primitive with a provisioned Routing Key.

From the list of ASPs within the AS table, an ASP in the ASP-ACTIVE state is selected and Dialogue Handling (DH) and Component Handling (CH) messages are constructed and issued on the corresponding SCTP association. If more than one ASP is in the ASP-ACTIVE state (i.e., traffic is to be load-shared across more than one ASP), one of the ASPs in the ASP-ACTIVE state is selected from the list. (If the ASPs are in Broadcast Mode, all active ASPs will be selected and the message sent to each of the active ASPs.) The selection algorithm is implementation dependent but could, for example, be round robin or based on the SLS. The appropriate selection algorithm must be chosen carefully as it is dependent on application assumptions and understanding of the degree of state coordination between the ASP-ACTIVE ASPs in the AS.

In addition, the message needs to be sent on the appropriate SCTP stream, again taking care to meet the message sequencing needs of the signalling application. Dialogue Handling (DH) and Component Handling (CH) messages **SHOULD** be sent on an SCTP stream other than stream '0'.

When there is no Routing Key match, or only a partial match, for an incoming SS7 message, a default treatment **MAY** be specified. Possible solutions are to provide a default Application Server at the SGP that directs all unallocated traffic to a (set of) default ASP(s), or to drop the message and provide a notification to Layer Management in an M-ERROR indication primitive. The treatment of unallocated traffic is implementation dependent.

4.1.3. Receipt of Primitive from the Layer Management

On receiving primitives from the local Layer Management, the TUA layer will take the requested action and provide an appropriate response primitive to Layer Management.

An M-SCTP_ESTABLISH request primitive from Layer Management at an ASP or IPSP will initiate the establishment of an SCTP association. The TUA layer will attempt to establish an SCTP association with the remote TUA peer by sending an SCTP-ASSOCIATE primitive to the local SCTP layer.

When an SCTP association has been successfully established, the SCTP will send an SCTP-COMMUNICATION_UP notification primitive to the local TUA layer. At the ASP or IPSP that initiated the request, the TUA layer will send an M-SCTP_ESTABLISH confirm primitive to Layer Management when the association setup is complete. At the peer TUA layer, an M-SCTP_ESTABLISH indication primitive is sent to Layer Management upon successful completion of an incoming SCTP association setup.

An M-SCTP_RELEASE request primitive from Layer Management initiates the shutdown of an SCTP association. The TUA layer accomplishes a graceful shutdown of the SCTP association by sending an SCTP-

SHUTDOWN primitive to the SCTP layer.

When the graceful shutdown of the SCTP association has been accomplished, the SCTP layer returns an SCTP-SHUTDOWN_COMPLETE notification primitive to the local TUA layer. At the TUA Layer that initiated the request, the TUA layer will send an M-SCTP_RELEASE confirm primitive to Layer Management when the association shutdown is complete. At the peer TUA Layer, an M-SCTP_RELEASE indication primitive is sent to Layer Management upon abort or successful shutdown of an SCTP association.

An M-SCTP_STATUS request primitive supports a Layer Management query of the local status of a particular SCTP association. The TUA layer simply maps the M-SCTP_STATUS request primitive to an SCTP_STATUS primitive to the SCTP layer. When the SCTP responds, the TUA layer maps the association status information to an M-SCTP_STATUS confirm primitive. No peer protocol is invoked.

Similar LM-to-TUA-to-SCTP and SCTP-to-TUA-to-LM primitive mappings can be described for the various other SCTP Upper Layer primitives in RFC 2960 [2960] such as INITIALIZE, SET PRIMARY, CHANGE HEARTBEAT, REQUEST HEARTBEAT, GET SRTT REPORT, SET FAILURE THRESHOLD, SET PROTOCOL PARAMETERS, DESTROY SCTP INSTANCE, SEND FAILURE, AND NETWORK STATUS CHANGE. Alternatively, these SCTP Upper Layer primitives (and Status as well) can be considered for modeling purposes as a Layer Management interaction directly with the SCTP Layer.

M-NOTIFY indication and M-ERROR indication primitives indicate to Layer Management the notification or error information contained in a received TUA *Notify (NTFY)* or *Error (ERR)* message respectively. These indications can also be generated based on local TUA events.

An M-ASP_STATUS request primitive supports a Layer Management query of the status of a particular local or remote ASP. The TUA layer responds with the status in an M-ASP_STATUS confirm primitive. No TUA peer protocol is invoked. An M-AS_STATUS request supports a Layer Management query of the status of a particular AS. The TUA responds with an M-AS_STATUS confirm primitive. No TUA peer protocol is invoked.

M-ASP_UP request, M-ASP_DOWN request, M-ASP_ACTIVE request and M- ASP_INACTIVE request primitives allow Layer Management at an ASP to initiate state changes. Upon successful completion, a corresponding confirm primitive is provided by the TUA layer to Layer Management. If an invocation is unsuccessful, an Error indication primitive is provided in the primitive. These requests result in outgoing *ASP Up (ASPUP)*, *ASP Down (ASPDN)*, *ASP Active (ASPAC)* and *ASP Inactive (ASPIA)* messages to the remote TUA peer at an SGP or IPSP.

4.2. Procedures to Support the Management of SCTP Associations

4.2.1. Receipt of TUA Peer Management Messages

Upon successful state changes resulting from reception of *ASP Up (ASPUP)*, *ASP Down (ASPDN)*, *ASP Active (ASPAC)* and *ASP Inactive (ASPIA)* messages from a peer TUA, the TUA layer **MAY** invoke corresponding M-ASP_UP, M-ASP_DOWN, M-ASP_ACTIVE and M-ASP_INACTIVE, M-AS_ACTIVE, M-AS_INACTIVE, and M-AS_DOWN indication primitives to the local Layer Management.

M-NOTIFY indication and M-ERROR indication primitives indicate to Layer Management the notification or error information contained in a received TUA *Notify (NTFY)* or *Error (ERR)* message. These indications can also be generated based on local TUA events.

All MGMT, ASPSM, ASPTM and RKM messages, except *BEAT*, *BEAT ACK* and *NTFY*, **SHOULD** be sent with sequenced delivery to ensure ordering. All MGMT, ASPSM and RKM messages, with the exception of *BEAT*, *BEAT ACK* and *NTFY* messages **MUST** be sent on SCTP stream '0'. ASPTM messages **MAY** be sent on one of the streams used to carry data traffic related to the Routing Context(s), to minimize possible message loss.

BEAT, *BEAT ACK*, and *NTFY* messages **MAY** be sent using out-of-order delivery, and **MAY** be sent on any stream.

4.3. AS and ASP State Maintenance

The TUA layer on the SGP maintains the state of each remote ASP, in each Application Server that the ASP is configured to receive traffic, as input to the TUA message distribution function. Similarly, where IPSPs use TUA in a point-to-point fashion, the TUA layer in an IPSP maintains the state of remote IPSPs.

Two IPSP models are defined with regards to the number of messages that are needed to an IPSP state change. They are defined as follows:

- (1) IPSP Single Exchange (SP) model. Only a single exchange of ASPTM or ASPSM messages is needed to change the IPSP state. This means that a request from one end and an acknowledgment from the other will be enough.
- (2) IPSP Double Exchange (DE) model. Both IPSPs have to send request messages and both IPSPs have to acknowledge the request messages from the other end. This results in a double exchange of ASPTM and ASPSM messages, one from each end.

To ensure interoperability, a TUA implementation supporting IPSP communication **MUST** support the IPSP SE model and **MAY** implement the IPSP DE model.

In section 4.3.1, only the SGP-ASP and IPSP SE scenarios are described. For the IPSP DE model, both IPSPs **MUST** follow the SGP side of the SGP-ASP procedures.

In section 4.3.2, only the SGP-ASP scenario is described. All of the procedures referring to an AS served by ASPs are also applicable to AS server by IPSPs.

In section 4.3.3, only the Management procedures for the SGP-ASP scenario are described. The corresponding Management procedures for IPSPs are directly inferred.

The remaining sections contain specific *IPSP Considerations* subsections.

4.3.1. ASP/IPSP States

The state of each remote ASP/IPSP, in each AS that it is configured to operate, is maintained in the TUA layer (i.e. in the SGP or peer IPSP, respectively). The state of a particular ASP/IPSP in a particular AS changes due to events. The events include:

- reception of messages from the peer TUA layer at the ASP/IPSP;
- reception of some messages from the peer TUA layer at other ASPs/IPSPs in the AS (e.g, ASP Active message indicating "Override");
- reception of indications from the SCTP layer; or,
- Local Management intervention.

The ASP/IPSP state transition diagram is shown in *Figure 5*. The possible states of an ASP/IPSP are:

ASP-DOWN: The remote TUA peer at the ASP/IPSP is unavailable or the related SCTP association is down. Initially all ASPs/IPSPs will be in this state. An ASP/IPSP in this state **SHOULD NOT** be sent any TUA messages, with the exception of *Heartbeat (BEAT)*, *ASP Down Ack (ASPDN ACK)* and *Error (ERR)* messages.

AS-INACTIVE: The Application Server is available but no application traffic is active (i.e., one or more related ASPs are in the ASP-INACTIVE state, but none in the ASP-ACTIVE state). The recovery timer T(r) is not running or has expired.

AS-ACTIVE: The Application Server is available and application traffic is active. This state implies that at least one ASP is in the ASP-ACTIVE state.

AS-PENDING: An active ASP has transitioned to ASP-INACTIVE or ASP-DOWN and it was the last remaining active ASP in the AS. A recovery timer T(r) **SHOULD** be started and all incoming signalling messages **SHOULD** be queued by the SGP. If an ASP becomes ASP-ACTIVE before T(r) expires, the AS is moved to the AS-ACTIVE state and all the queued messages will be sent to the ASP.

If T(r) expires before an ASP becomes ASP-ACTIVE, and the SGP has no other alternative, the SGP may stop queuing messages and discard all previously queued messages. The AS will move to the AS-INACTIVE state if at least one ASP is in ASP-INACTIVE state, otherwise it will move to AS-DOWN state.

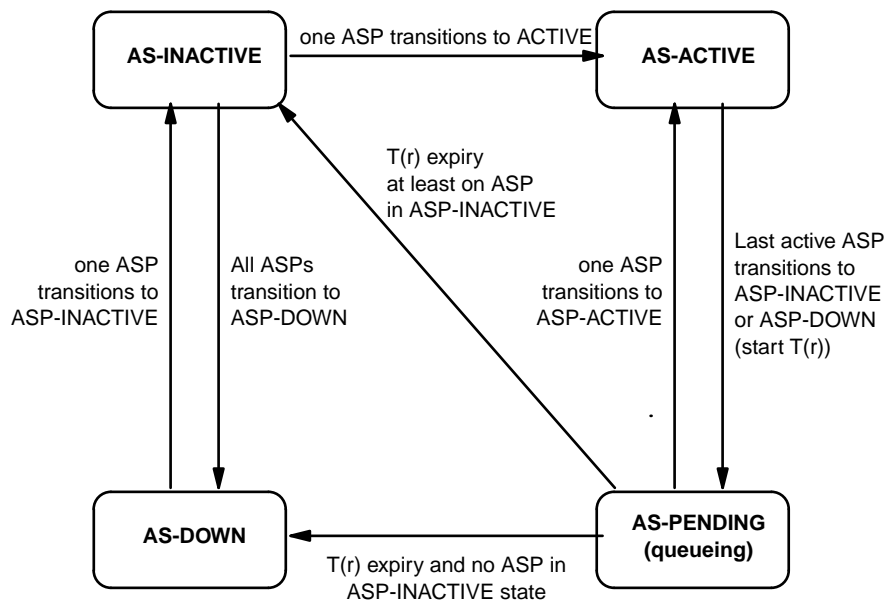

Figure 6. AS State Transition Diagram

Figure 6 shows an example AS state machine for the case where the AS data is pre-configured. For other cases where the ASP configuration data is created dynamically, there would be differences in the state machine, especially at creation of the AS.

For example, where the AS configuration data is not created until Registration of the first ASP, the AS-INACTIVE state is entered directly upon the first successful REG REQ from an ASP. Another example is where the AS configuration data is not created until the first ASP successfully enters the ASP-ACTIVE state. In this case the AS-ACTIVE state is entered directly.

4.3.2.1. IPSP Considerations

The AS state diagram for the AS-SG case is applicable for IPSP communication.

4.3.3. TUA Management Procedures for Primitives

Before the establishment of an SCTP association the ASP state at both the SGP and ASP is assumed to be in the state ASP-DOWN.

Once the SCTP association is established (see Section 4.2.1) and assuming that the local TC-User is ready, the local TUA ASP Maintenance (ASPM) function will initiate the relevant procedures, using the ASP Up, ASP Down, ASP Active and ASP Inactive messages to convey the ASP state to the SGP (see Section 4.3.4).

If the TUA layer subsequently receives an SCTP-COMMUNICATION_DOWN or SCTP-RESTART indication primitive from the underlying SCTP layer, it will inform the Layer Management by invoking the M-SCTP_STATUS indication primitive. The state of the ASP will be moved to ASP-DOWN.

At an ASP, the TC-User will be informed of the unavailability of any affected SS7 destination through the use of N-PCSTATE indication primitives.

In the case of SCTP-COMMUNICATION_DOWN, the SCTP client **MAY** try to re-establish the SCTP association. This **MAY** be done by the TUA layer automatically, or Layer Management **MAY** re-establish using the M-SCTP_ESTABLISH request primitive.

In the case of an SCTP-RESTART indication at an ASP, the ASP is now considered by its TUA peer to be in the ASP-DOWN state. The ASP, if it is to recover, must begin any recovery with the ASP-Up procedure.

4.3.4. ASPM Procedures for Peer-to-Peer Messages

4.3.4.1. ASP Up Procedures

After an ASP has successfully established an SCTP association to an SGP, the SGP waits for the ASP to send an *ASP Up (ASPUP)* message, indicating that the ASP TUA peer is available. The ASP is always the initiator of the *ASP Up (ASPUP)* message. This action **MAY** be initiated at the ASP by an M-ASP_UP request primitive from Layer Management or **MAY** be initiated automatically by an TUA management function.

When an *ASP Up (ASPUP)* message is received at an SGP and internally the remote ASP is in the ASP-DOWN state and not considered locked-out for local management reasons, the SGP marks the remote ASP in the state ASP-INACTIVE and informs Layer Management with an M-ASP_Up indication primitive. If the SGP is aware, via current configuration data, which Application Servers the ASP is configured to operate in, the SGP updates the ASP state to ASP-INACTIVE in each AS that it is a member.

Alternatively, the SGP may move the ASP into a pool of Inactive ASPs available for future configuration within Application Server(s), determined in a subsequent Registration Request or ASP Active procedure. If the *ASP Up (ASPUP)* message contains an ASP Identifier, the SGP should save the ASP Identifier for that ASP. The SGP **MUST** send an *ASP Up Ack (ASPUP ACK)* message in response to a received *ASP Up (ASPUP)* message even if the ASP is already marked as ASP-INACTIVE at the SGP.

If for any local reason (e.g, management lock-out) the SGP cannot respond with an *ASP Up Ack (ASPUP ACK)* message, the SGP responds to an *ASP Up (ASPUP)* message with an *Error (ERR)* message with Reason "Refused - Management Blocking".

At the ASP, the *ASP Up Ack (ASPUP ACK)* message received is not acknowledged. Layer Management is informed with an M-ASP_UP confirm primitive.

When the ASP sends an *ASP Up (ASPUP)* message it starts timer T(ack). If the ASP does not receive a response to an *ASP Up (ASPUP)* message within T(ack), the ASP **MAY** restart T(ack) and resend *ASP Up*

(*ASPUP*) messages until it receives an *ASP Up Ack (ASPUP ACK)* message. T(ack) is provisionable, with a default of 2 seconds. Alternatively, retransmission of *ASP Up (ASPUP)* messages **MAY** be put under control of Layer Management. In this method, expiry of T(ack) results in an M-ASP_UP confirm primitive carrying a negative indication.

The ASP must wait for the *ASP Up Ack (ASPUP ACK)* message before sending any other TUA messages (e.g, ASP Active or REG REQ). If the SGP receives any other TUA messages before *ASPUP* message is received (other than ASPDN - see Section 4.3.4.2), the SGP **SHOULD** discard them.

If an *ASP Up (ASPUP)* message is received and internally the remote ASP is in the ASP-ACTIVE state, an *ASP Up Ack (ASPUP ACK)* message is returned, as well as an *Error (ERR)* message ("Unexpected Message), and the remote ASP state is changed to ASP-INACTIVE in all relevant Application Servers.

If an *ASP Up (ASPUP)* message is received and internally the remote ASP is already in the ASP-INACTIVE state, an *ASP Up Ack (ASPUP ACK)* message is returned and no further action is taken.

4.3.4.1.1. TUA Version Control

If an *ASP Up (ASPUP)* message with an unsupported version is received, the receiving end responds with an *Error (ERR)* message, indicating the version the receiving node supports and notifies Layer Management.

This is useful when protocol version upgrades are being performed in a network. A node upgraded to a newer version should support the older versions used on other nodes it is communicating with. Because ASPs initiate the ASP Up procedure it is assumed that the *Error (ERR)* message would normally come from the SGP.

4.3.4.1.2. IPSP Considerations

An IPSP may be considered in the ASP-INACTIVE state after and *ASPUP* or *ASPUP Ack* has been received from it. An IPSP can be considered in the ASP-DOWN state after an *ASPDN* or *ASPDN Ack* has been received from it. The IPSP may inform Layer Management of the change in state of the remote IPSP using M-ASP_UP or M-ASP_DN indication or confirmation primitives.

Alternatively, when using the IPSP DE model, an interchange of *ASPUP* messages from each end **MUST** be performed. Four messages are needed for completion.

If for any local reason (e.g, management lock-out) and IPSP cannot respond to an *ASP Up (ASPUP)* message with an *ASP Up Ack (ASPUP ACK)* message, it responds to an *ASP Up (ASPUP)* message with an *Error (ERR)* message with Reason "Refused - Management Blocking" and leaves the remote IPSP in the ASP-DOWN state.

4.3.4.2. ASP Down Procedures

The ASP will send an *ASP Down (ASPDN)* message to an SGP when the ASP wishes to be removed from service in all Application Servers that it is a member and no longer receive any DH, CH, SSNM or ASPTM messages. This action **MAY** be initiated at the ASP by an M-ASP_DOWN request primitive from Layer Management or **MAY** be initiated automatically by an TUA management function.

Whether the ASP is permanently removed from any AS is a function of configuration management. Whenever the ASP previously used the Registration procedures (see Section 4.4.1) to register within Application Servers but has not deregistered from all of them prior to sending the *ASP Down (ASPDN)* message, the SGP **MUST** consider the ASP as Deregistered in all Application Servers that it is still a member.

The SGP marks the ASP as ASP-DOWN, informs Layer Management with an M-ASP_Down indication primitive, and returns an *ASP Down Ack (ASPDN ACK)* message to the ASP.

The SGP **MUST** send an *ASP Down Ack (ASPDN ACK)* message in response to a received *ASP Down (ASPDN)* message from the ASP even if the ASP is already marked as ASP-DOWN at the SGP.

At the ASP, the *ASP Down Ack (ASPDN ACK)* message received is not acknowledged. Layer Management is informed with an M-ASP_DOWN confirm primitive. If the ASP receives an *ASP Down Ack* without having sent an *ASP Down (ASPDN)* message, the ASP should now consider itself as in the ASP-DOWN state. If the ASP was previously in the ASP-ACTIVE or ASP_INACTIVE state, the ASP should then initiate procedures to return itself to its previous state.

When the ASP sends an *ASP Down (ASPDN)* message it starts timer T(ack). If the ASP does not receive a response to an *ASP Down (ASPDN)* message within T(ack), the ASP **MAY** restart T(ack) and resend *ASP Down (ASPDN)* messages until it receives an *ASP Down Ack (ASPDN ACK)* message. T(ack) is provisionable, with a default of 2 seconds. Alternatively, retransmission of *ASP Down (ASPDN)* messages **MAY** be put under control of Layer Management. In this method, expiry of T(ack) results in an M-ASP_DOWN confirm primitive carrying a negative indication.

4.3.4.3. ASP Active Procedures

Anytime after the ASP has received an *ASP Up Ack (ASPUP ACK)* message from the SGP or IPSP, the ASP **MAY** send an *ASP Active (ASPAC)* message to the SGP indicating that the ASP is ready to start processing traffic. This action **MAY** be initiated at the ASP by an M-ASP_ACTIVE request primitive from Layer Management or **MAY** be initiated automatically by an TUA management function. Whenever an ASP wishes to process the traffic for more than one Application Server across a common SCTP association, the *ASP Active (ASPAC)* message(s) **SHOULD** contain a list of one or more Routing Contexts to indicate for which Application Servers the *ASP Active (ASPAC)* message applies. It is not necessary for the ASP to include all Routing Contexts of interest in a single *ASP Active (ASPAC)* message, thus requesting to become active in all Routing Contexts at the same time. Multiple *ASP Active (ASPAC)* messages **MAY** be used to activate within the Application Servers independently, or in sets. Whenever an *ASP Active (ASPAC)* message does not contain a Routing Context parameter, the receiver must know, via configuration data, which Application Server(s) the ASP is a member.

For the Application Servers that the ASP can successfully activate, the SGP or IPSP responds with one or more *ASP Active Ack (ASPAC ACK)* messages, including the associated Routing Context(s) and reflecting any Traffic Mode Type values present in the related *ASP Active (ASPAC)* message. The Routing Context parameter **MUST** be included in the *ASP Active Ack (ASPAC ACK)* message(s) if the received *ASP Active (ASPAC)* message contained any Routing Contexts. Depending on any Traffic Mode Type request in the *ASP Active (ASPAC)* message or local configuration data if there is no request, the SGP moves the ASP to the correct ASP traffic state within the associated Application Server(s). Layer Management is informed with an M-ASP_Active indication. If the SGP or IPSP receives any DH or CH messages before an *ASP Active (ASPAC)* message is received, the SGP or IPSP **MAY** discard them. By sending an *ASP Active Ack (ASPAC ACK)* message, the SGP or IPSP is now ready to receive and send traffic for the related Routing Context(s). The ASP **SHOULD NOT** send DH or CH messages for the related Routing Context(s) before receiving an *ASP Active Ack (ASPAC ACK)* message, or it will risk message loss.

Multiple *ASP Active Ack (ASPAC ACK)* messages **MAY** be used in response to an *ASP Active (ASPAC)* message containing multiple Routing Contexts, allowing the SGP or IPSP to independently acknowledge the *ASP Active (ASPAC)* message for different (sets of) Routing Contexts. The SGP or IPSP **MUST** send an *Error (ERR)* message ("Invalid Routing Context") for each Routing Context value that cannot be successfully activated.

Whenever an "out-of-the-blue" *ASP Active (ASPAC)* message is received (i.e., the ASP has not registered with the SG or the SG has no static configuration data for the ASP), the message **MAY** be silently discarded.

The SGP **MUST** send an *ASP Active Ack (ASPAC ACK)* message in response to a received *ASP Active (ASPAC)* message from the ASP, if the ASP is already marked in the ASP-ACTIVE state at the SGP.

At the ASP, the *ASP Active Ack (ASPAC ACK)* message received is not acknowledged. Layer Management is informed with an M-ASP_ACTIVE confirm primitive. It is possible for the ASP to receive DH or CH message(s) before the *ASP Active Ack (ASPAC ACK)* message as the ASP Active Ack and DH or CH messages from an SG or IPSP may be sent on different SCTP streams. Message loss is possible, as the ASP does not consider itself in the ASP-ACTIVE state until reception of the *ASP Active Ack (ASPAC ACK)* message.

When the ASP sends an *ASP Active (ASPAC)* message it starts timer T(ack). If the ASP does not receive a response to an *ASP Active (ASPAC)* message within T(ack), the ASP **MAY** restart T(ack) and resend *ASP Active (ASPAC)* messages until it receives an *ASP Active Ack (ASPAC ACK)* message. T(ack) is provisionable, with a default of 2 seconds. Alternatively, retransmission of *ASP Active (ASPAC)* messages **MAY** be put under control of Layer Management. In this method, expiry of T(ack) results in an M-ASP_ACTIVE confirm primitive carrying a negative indication.

There are three modes of Application Server traffic handling in the SGP TUA layer: Override, Load-share and Broadcast. When included, the Traffic Mode Type parameter in the *ASP Active (ASPAC)* message indicates the traffic-handling mode to be used in a particular Application Server. If the SGP determines that the mode indicated in an *ASP Active (ASPAC)* message is unsupported or incompatible with the mode currently configured for the AS, the SGP responds with an *Error (ERR)* message ("Unsupported/Invalid Traffic Handling Mode"). If the traffic-handling mode of the Application Server is not already known via configuration data, then the traffic-handling mode indicated in the first *ASP Active (ASPAC)* message causing the transition of the Application Server state to AS-ACTIVE **MAY** be used to set the mode.

In the case of an Override mode AS, reception of an *ASP Active (ASPAC)* message at an SGP causes the (re)direction of all traffic for the AS to the ASP that sent the *ASP Active (ASPAC)* message. Any previously active ASP in the AS is now considered to be in state ASP-INACTIVE and **SHOULD** no longer receive traffic from the SGP within the AS. The SGP or IPSP then **MUST** send a *Notify (NTFY)* message ("Alternate ASP Active") to the previously active ASP in the AS, and **SHOULD** stop traffic to or from that ASP. The ASP receiving this Notify **MUST** consider itself now in the ASP-INACTIVE state, if it is not already aware of this via inter-ASP communication with the Overriding ASP.

In the case of a Load-share mode AS, reception of an *ASP Active (ASPAC)* message at an SGP or IPSP causes the direction of traffic to the ASP sending the *ASP Active (ASPAC)* message, in addition to all the other ASPs that are currently active in the AS. The algorithm at the SGP for load-sharing traffic within an AS to all the active ASPs is implementation dependent. The algorithm could, for example, be round robin or based on information in the DH or CH message.

An SGP or IPSP, upon reception of an *ASP Active (ASPAC)* message for the first ASP in a Load-share AS, **MAY** choose not to direct traffic to a newly active ASP until it determines that there are sufficient resources to handle the expected load (e.g, until there are "n" ASPs in state ASP-ACTIVE in the AS).

All ASPs within a load-sharing mode AS must be able to process any DH or CH message received for the AS, to accommodate any potential fail-over or re-balancing of the offered load.

In the case of a Broadcast mode AS, reception of an *ASP Active (ASPAC)* message at an SGP or IPSP causes the direction of traffic to the ASP sending the *ASP Active (ASPAC)* message, in addition to all the other ASPs that are currently active in the AS. The algorithm at the SGP for broadcasting traffic within an AS to all the active ASPs is a simple broadcast algorithm, where every message is sent to each of the active ASPs. An SGP or IPSP, upon reception of an *ASP Active (ASPAC)* message for the first ASP in a Broadcast AS, **MAY** choose not to direct traffic to a newly active ASP until it determines that there are sufficient resources to handle the expected load (e.g, until there are "n" ASPs in state ASP-ACTIVE in the AS).

Whenever an ASP in a Broadcast mode AS becomes ASP-ACTIVE, the SGP **MUST** tag the first DH or CH message broadcast in each SCTP stream with a unique Correlation Id parameter. The purpose of this Correlation

It is to permit the newly active ASP to synchronize its processing of traffic in each ordered stream with the other ASPs in the broadcast group.

4.3.4.3.1. IPSP Considerations

Either of the IPSPs can initiate communication. When an IPSP receives an ASP Active, it should mark the peer as ASP-ACTIVE and return an *ASP Active Ack (ASPAC ACK)* message. An ASP receiving an *ASP Active Ack (ASPAC ACK)* message may mark the peer as ASP-Active, if it is not already in the ASP-ACTIVE state.

Alternatively, when using the IPSP DE model, an interchange of *ASPAC* messages from each end **MUST** be performed. Four messages are needed for completion.

4.3.4.4. ASP Inactive Procedures

When an ASP wishes to withdraw from receiving traffic within an AS, or the ASP wants to initiate the process of deactivation, the ASP sends an *ASP Inactive (ASPIA)* message to the SGP or IPSP.

An *ASP Inactive (ASPIA)* message **MUST** always be responded by the peer (although other messages may be sent in the middle):

- If the corresponding RK is registered (statically or dynamically), the peer should respond with an *ASP Inactive Ack (ASPIA Ack)* message.
- If the RK is not registered, or the RC information is not valid, the peer must respond with an *Error (ERR)* message with error code "Invalid Routing Context".
- If the RC is missing and its specification is needed according to the used configuration, the peer must respond with an *Error (ERR)* message with error code "No Configured AS for ASP".

The action of sending the *ASP Inactive (ASPIA)* message **MAY** be initiated at the ASP by an M-ASP_INACTIVE request primitive from Layer Management or **MAY** be initiated automatically by an TUA management function. Whenever an ASP is processing the traffic for more than one Application Server across a common SCTP association, the *ASP Inactive (ASPIA)* message contains one or more Routing Contexts to indicate for which Application Servers the *ASP Inactive (ASPIA)* message applies. Whenever an *ASP Inactive (ASPIA)* message does not contain a Routing Context parameter, the receiver must know, via configuration data, which Application Servers the ASP is a member and move the ASP to the ASP-INACTIVE state in each all Application Servers.

In the case of an Override mode AS, where another ASP has already taken over the traffic within the AS with an *ASP Active (ASPAC)* message, the ASP that sends the *ASP Inactive (ASPIA)* message is already considered by the SGP to be in state ASP-INACTIVE. An *ASP Inactive Ack (ASPIA ACK)* message is sent to the ASP, after ensuring that all traffic is stopped to the ASP.

In the case of a Load-share mode AS, the SGP moves the ASP to the ASP-INACTIVE state and the AS traffic is re-allocated across the remaining ASPs in the state ASP-ACTIVE, as per the load-sharing algorithm currently used within the AS. A *Notify (NTFY)* message ("Insufficient ASP resources active in AS") **MAY** be sent to all inactive ASPs, if required. An *ASP Inactive Ack (ASPIA ACK)* message is sent to the ASP after all traffic is halted and Layer Management is informed with an M-ASP_INACTIVE indication primitive.

In the case of a Broadcast mode AS, the SGP moves the ASP to the ASP-INACTIVE state and the AS traffic is broadcast only to the remaining ASPs in the state ASP-ACTIVE. A *Notify (NTFY)* message ("Insufficient ASP resources active in AS") **MAY** be sent to all inactive ASPs, if required. An *ASP Inactive Ack (ASPIA ACK)* message is sent to the ASP after all traffic is halted and Layer Management is informed with an M-ASP_INACTIVE indication primitive.

Multiple *ASP Inactive Ack (ASPIA ACK)* messages **MAY** be used in response to an *ASP Inactive (ASPIA)* message containing multiple Routing Contexts, allowing the SGP or IPSP to independently acknowledge for different (sets of) Routing Contexts. The SGP or IPSP sends an *Error (ERR)* ("Invalid Routing Context") message for each invalid or not configured Routing Context value in a received *ASP Inactive (ASPIA)* message.

The SGP **MUST** send an *ASP Inactive Ack (ASPIA ACK)* message in response to a received *ASP Inactive (ASPIA)* message from the ASP and the ASP is already marked as ASP-INACTIVE at the SGP.

At the ASP, the *ASP Inactive Ack (ASPIA ACK)* message received is not acknowledged. Layer Management is informed with an M-ASP_INACTIVE confirm primitive. If the ASP receives an *ASP Inactive Ack* without having sent an *ASP Inactive (ASPIA)* message, the ASP should now consider itself as in the ASP-INACTIVE state. If the ASP was previously in the ASP-ACTIVE state, the ASP should then initiate procedures to return itself to its previous state. When the ASP sends an *ASP Inactive (ASPIA)* message it starts timer T(ack). If the ASP does not receive a response to an *ASP Inactive (ASPIA)* message within T(ack), the ASP **MAY** restart T(ack) and resend *ASP Inactive (ASPIA)* messages until it receives an *ASP Inactive Ack (ASPIA ACK)* message. T(ack) is provisionable, with a default of 2 seconds. Alternatively, retransmission of *ASP Inactive (ASPIA)* messages **MAY** be put under control of Layer Management. In this method, expiry of T(ack) results in a M-ASP_Inactive confirm primitive carrying a negative indication.

If no other ASPs in the Application Server are in the state ASP-ACTIVE, the SGP **MUST** send a *Notify (NTFY)* message ("AS-Pending") to all of the ASPs in the AS which are in the state ASP-INACTIVE. The SGP **SHOULD** start buffering the incoming messages for T(r) seconds, after which messages **MAY** be discarded. T(r) is configurable by the network operator. If the SGP receives an *ASP Active (ASPAC)* message from an ASP in the AS before expiry of T(r), the buffered traffic is directed to that ASP and the timer is canceled. If T(r) expires, the AS is moved to the ASP-INACTIVE state.

4.3.4.4.1. IPSP Considerations

An IPSP may be considered in the ASP-INACTIVE state by a remote IPSP after an *ASP Inactive* or *ASP Inactive Ack (ASPIA ACK)* message has been received from it.

Alternatively, when using the IPSP DE model, an interchange of *ASPIA* messages from each end **MUST** be performed. Four messages are needed for completion.

4.3.4.5. Notify Procedures

A *Notify (NTFY)* message reflecting a change in the AS state **MUST** be sent to all ASPs in the AS, except those in the ASP-DOWN state, with appropriate Status Information and any ASP Identifier of the failed ASP. At the ASP, Layer Management is informed with an M-NOTIFY indication primitive. The *Notify (NTFY)* message must be sent whether the AS state change was a result of an ASP failure or reception of an ASP State management (ASPSM) or ASP Traffic Management (ASPTM) message. In the second case, the *Notify (NTFY)* message **MUST** be sent after any ASP State or Traffic Management related acknowledgments messages (e.g, ASP Up Ack, ASP Down Ack, ASP Active Ack, or ASP Inactive Ack).

Whenever a *Notify (NTFY)* ("AS-PENDING") message is sent by an SGP that now has no ASPs active to service the traffic, or where a *Notify NTFY* ("Insufficient ASP resources active in AS") message **MUST** be sent in the Load-share or Broadcast mode, the *Notify (NTFY)* message does not explicitly compel the ASP(s) receiving the message to become active. The ASPs remain in control of what (and when) traffic action is taken.

Whenever a *Notify (NTFY)* message does not contain a Routing Context parameter, the receiver must know, via configuration data, of which Application Servers the ASP is a member and take the appropriate action in each AS.

4.3.4.5.1. IPSP Considerations (NTFY)

Notify works in the same manner as in the SG-AS case. One of the IPSPs can send this message to any remote IPSP that is not in the ASP-DOWN state.

4.3.4.6. Heartbeat Procedures

The optional Heartbeat procedures **MAY** be used when operating over transport layers that do not have their own heartbeat mechanism for detecting loss of the transport association (i.e., other than SCTP).

Either TUA peer may optionally send *Heartbeat (BEAT)* messages periodically, subject to a provisionable timer T(beat). Upon receiving a *Heartbeat (BEAT)* message, the TUA peer **MUST** respond with a *Heartbeat Ack (BEAT ACK)* message.

If no *Heartbeat Ack (BEAT ACK)* message (or any other TUA message) is received from the TUA peer within $2 * T(\text{beat})$, the remote TUA peer is considered unavailable. Transmission of *Heartbeat (BEAT)* messages is stopped and the signalling process **SHOULD** attempt to re-establish communication if it is configured as the client for the disconnected TUA peer.

The *Heartbeat (BEAT)* message may optionally contain an opaque Heartbeat Data parameter that **MUST** be echoed back unchanged in the related *Heartbeat Ack (BEAT ACK)* message. The sender, upon examining the contents of the returned *Heartbeat Ack (BEAT ACK)* message, **MAY** choose to consider the remote TUA peer as unavailable. The contents and format of the Heartbeat Data parameter is implementation-dependent and only of local interest to the original sender. The contents may be used, for example, to support a Heartbeat sequence algorithm (to detect missing Heartbeats), or a time-stamp mechanism (to evaluate delays).

Note: Heartbeat related events are not shown in *Figure 5 "ASP State Transition Diagram"*.

4.4. Routing Key Management Procedures

4.4.1. Registration

An ASP **MAY** dynamically register with an SGP as an ASP within an Application Server using the *REG REQ* message. A Routing Key parameter in the *REG REQ* message specifies the parameters associated with the Routing Key.

The SGP examines the contents of the received Routing Key parameter and compares it with the currently provisioned Routing Keys. If the received Routing Key matches an existing SGP Routing Key entry, and the ASP is not currently included in the list of ASPs for the related Application Server, the SGP **MAY** authorize the ASP to be added to the AS. Or, if the Routing Key does not currently exist and the received Routing Key data is valid and unique, an SGP supporting dynamic configuration **MAY** authorize the creation of a new Routing Key and related Application Server and add the ASP to the new AS. In either case, the SGP returns a *Registration Response (REG RSP)* message to the ASP, containing the same Local-RK-Identifier as provided in the initial request, and a Registration Result "Successfully Registered". A unique Routing Context value assigned to the SGP Routing Key is included. The method of Routing Context value assignment at the SGP is implementation dependent but must be guaranteed to be unique for each Application Server or Routing Key supported by the SGP. If the SGP determines that the received Routing Key data is invalid, or contains invalid parameter values, the SGP returns a *Registration Response (REG RSP)* message to the ASP, containing a Registration Result "Error - Invalid Routing Key", "Error - Invalid DPC", "Error - Invalid Network Appearance" as appropriate.

If the SGP does not support the registration procedure, the SGP returns an *Error (ERR)* message to the ASP, with an error code of "Unsupported Message Type".

If the SGP determines that a unique Routing Key cannot be created, the SGP returns a *Registration Response (REG RSP)* message to the ASP, with a Registration Status of "Error - "Cannot Support Unique Routing." An incoming signalling message received at an SGP should not match against more than one Routing Key.

If the SGP does not authorize the registration request, the SGP returns a *REG RSP* message to the ASP containing the Registration Result "Error - Permission Denied".

If an SGP determines that a received Routing Key does not currently exist and the SGP does not support dynamic configuration, the SGP returns a *Registration Response (REG RSP)* message to the ASP, containing a Registration Result "Error - Routing Key not Currently Provisioned".

If an SGP determines that a received Routing Key does not currently exist and the SGP supports dynamic configuration but does not have the capacity to add new Routing Key and Application Server entries, the SGP returns a *Registration Response (REG RSP)* message to the ASP, containing a Registration Result "Error - Insufficient Resources".

If an SGP determines that one or more of the Routing Key parameters are not supported for the purpose of creating new Routing Key entries, the SGP returns a *Registration Response (REG RSP)* message to the ASP, containing a Registration Result "Error - Unsupported RK parameter field". This result **MAY** be used if, for example, the SGP does not support RK Address parameter.

A Registration Response "Error - Unsupported Traffic Handling Mode" is returned if the Routing Key in the REG REQ contains a Traffic Handling Mode that is inconsistent with the presently configured mode for the matching Application Server.

An ASP **MAY** register multiple Routing Keys at once by including a number of Routing Key parameters in a single *REG REQ* message. The SGP **MAY** respond to each registration request in a single *REG RSP* message, indicating the success or failure result for each Routing Key in a separate Registration Result parameter. Alternatively the SGP **MAY** respond with multiple *REG RSP* messages, each with one or more Registration Result parameters. The ASP uses the Local-RK-Identifier parameter to correlate the requests with the responses.

An ASP **MAY** modify an existing Routing Key by including a Routing Context parameter in the REG REQ. If the SGP determines that the Routing Context applies to an existing Routing Key, the SG **MAY** adjust the existing Routing Key to match the new information provided in the Routing Key parameter. A Registration Response "Error - Routing Key Change Refused" is returned if the SGP does not accept the modification of the Routing Key.

Upon successful registration of an ASP in an AS, the SGP can now send related SS7 Signalling Network Management messaging, if this did not previously start upon the ASP transition to state ASP-INACTIVE

4.4.2. Deregistration

An ASP **MAY** dynamically deregister with an SGP as an ASP within an Application Server using the *DEREG REQ* message. A Routing Context parameter in the *DEREG REQ* message specifies which Routing Keys to deregister. An ASP **SHOULD** move to the ASP-INACTIVE state for an Application Server before attempting to deregister the Routing Key (i.e., deregister after receiving an ASP Inactive Ack). Also, an ASP **SHOULD** deregister from all Application Servers that it is a member before attempting to move to the ASP-Down state.

The SGP examines the contents of the received Routing Context parameter and validates that the ASP is currently registered in the Application Server(s) related to the included Routing Context(s). If validated, the ASP is deregistered as an ASP in the related Application Server.

The deregistration procedure does not necessarily imply the deletion of Routing Key and Application Server configuration data at the SGP. Other ASPs may continue to be associated with the Application Server, in which case the Routing Key data **MUST NOT** be deleted. If a Deregistration results in no more ASPs in an Application Server, an SGP **MAY** delete the Routing Key data.

The SGP acknowledges the deregistration request by returning a *DEREG RSP* message to the requesting ASP. The result of the deregistration is found in the Deregistration Result parameter, indicating success or failure with cause.

An ASP **MAY** deregister multiple Routing Contexts at once by including a number of Routing Contexts in a single *DEREG REQ* message. The SGP **MAY** respond to each deregistration request in a single *DEREG RSP* message, indicating the success or failure result for each Routing Context in a separate Deregistration Result parameter.

4.4.3. IPSP Considerations (REG/DEREG)

The Registration and Deregistration procedures work in the IPSP cases in the same way as in AS-SG cases. An IPSP may register an RK in the remote IPSP. An IPSP is responsible for deregistering the RKs that it has registered.

4.5. Procedures to Support Point Code and Subsystem State

4.5.1. At an SGP

On receiving an N-STATE, N-PCSTATE, N-COORD indication primitive from the nodal inter-working function at an SGP, the SGP TUA layer will send a corresponding SS7 Signalling Network Management (SSNM) DUNA, DAVA, DUPU, DRST or *SCON* message (see Section 3) to the TUA peers at concerned ASPs. The TUA layer must fill in various fields of the SSNM messages consistently with the information received in the primitives.

SSNM messages **SHOULD NOT** be sent on stream "0" and **MAY** use ordered delivery.

4.5.2. At an ASP

4.5.2.1. Single SG Configurations

At an ASP, upon receiving an SS7 Signalling Network Management (SSNM) message from the remote TUA Peer, the TUA layer invokes the appropriate primitive indications to the resident TC-Users. Local management is informed.

Whenever a local event has caused the unavailability or congestion status of SS7 destinations, user parts or subsystems, the TUA layer at the ASP **SHOULD** pass up appropriate indications in the primitives to the TUA User, as though equivalent SSNM messages were received. For example, the loss of an SCTP association to an SGP may cause the unavailability of a set of SS7 destinations, user parts or subsystems. N-PCSTATE indication primitives to the TUA User are appropriate.

4.5.2.2. Multiple SG Configurations

At an ASP, upon receiving a SS7 Signalling Network Management (SSNM) message from the remote TUA Peer, the TUA layer updates the status of the affected route(s) via the originating SG and determines, whether or not the overall availability or congestion status of the effected destination(s) or subsystem(s) has changed. If so, the TUA layer invokes the appropriate primitive indications to the resident TC-Users [1]. Local management is informed.

4.5.3. ASP Auditing

An ASP may optionally initiate an audit procedure to inquire of an SG the availability and, if the national congestion method with multiple congestion levels and message priorities is used, congestion status of an SS7 destination or set of destinations. In addition, the ASP may inquire of an SG the availability and congestion status of a subsystem. A *Destination Audit (DAUD)* message is sent from the ASP to the SGP requesting the current availability and congestion status of one or more SS7 destinations or subsystems.

The *DAUD* message **MAY** be sent with unordered delivery. The ASP **MAY** send the *DAUD* in the following cases:

- Periodic: A Timer originally set upon reception of a *DUNA*, *SCON* or *DRST* message has expired without a subsequent *DAVA*, *DUNA*, *SCON* or *DRST* message updating the availability and congestion status of the affected destinations or subsystems. The Timer is reset upon issuing a *DAUD*. In this case the *DAUD* is sent to the SGP that originally sent the *SSNM* message [2].
- Isolation: The ASP is newly ASP-ACTIVE or has been isolated from an SG for an extended period. The ASP **MAY** request the availability and congestion status of one or more SS7 destinations or subsystems to which it expects to communicate.

The SGP **SHOULD** either respond to a *DAUD* messages with *SSNM* messages indicating the availability and congestion status of the destination or subsystem, or **SHOULD** respond with an *ERR* ("Destination Status Unknown") or *ERR* ("Subsystem Status Unknown") message for each destination or subsystem requested in the *DAUD* message.

The status of each SS7 destination or subsystem requested is indicated in a *DUNA* message (if unavailable), a *DAVA* message (if available), or a *DRST* (if restricted and the SGP supports this feature). If the SS7 destination or subsystem is available and congested, the SGP responds with an *SCON* message in addition to the *DAVA* message. If the SS7 destination is restricted and congested, the SGP responds with an *SCON* message in addition to the *DRST*. If the SGP cannot return information on the availability or congestion status of the SS7 destination or subsystem, the SGP responds with an *ERR* ("Destination Status Unknown") or *ERR* ("Subsystem Status Unknown") with a list of all the destinations and subsystems for which the SGP cannot provide information.

In some cases, the SGP **MAY** chose not to respond to a *DAUD* message or a component of a *DAUD* message on the basis of policy [3].

Any *DUNA* or *DAVA* message in response to a *DAUD* message **MAY** contain a list of Affected Point Codes.

4.5.4. TCAP – TUA Interworking at the SG

On the SG, the TCAP routing or interworking function determines that the message must be sent to an AS via the TUA stack, based on information in the incoming message. The TUA outgoing mapping function identifies the appropriate Application Server (AS) and selects an active ASP from the list of ASPs servicing this AS. The appropriate ASP can be determined based on the routing information in the incoming message, local load sharing information, etc. The appropriate TUA message is then constructed and sent to the appropriate endpoint, via the correct SCTP association and stream.

4.5.4.1. Primitives received from the local TC-User

These support the TUA transport of TC-User boundary primitives. The same services as supported by TCAP are to be provided by TUA. The TC-users at the SG should be able to use the same primitive interface to TCAP/TUA without any changes. The TCAP-TUA interworking function takes care of selecting the appropriate stack.

The TUA needs to setup and maintain the appropriate SCTP association to the selected endpoint. TUA also manages the usage of SCTP streams. The address information passed by the TUA-user at an ASP must contain:
.np a valid SS7 address to reach a destination in the SS7 network via the appropriate SCTP association to a SG
.np a valid IP address or host name to reach another ASP in the IP network via the appropriate SCTP association.

4.5.4.2. Segmenting and Reassembly of Components

When it is expected that TCAP signalling messages will not fit into the maximum PDU size of the underlying transport (e.g. SCCP, MTP), then segmentation and reassembly **SHOULD** be performed by the TC-User. In the event that the SG receives a *TQRY*, *TCNV* and *TRSP* message with included or associated components that exceed the maximum PDU size of the underlying transport, the SGP will respond with a *TNOT* message with "Segmentation Not Supported" or "Segmentation Failed" or "Destination cannot perform reassembly" indicated in the *Report Cause* within the *TNOT* message considering local SG SCCP procedures [4].

Notes for §4

- [1] **IMPLEMENTATION NOTE:**– To accomplish the handling of SSNM messages from multiple SGs in a multiple SG configuration, the TUA layer at an ASP maintains the status of routes via each SG.
- [2] **IMPLEMENTATION NOTE:**– In the case of a Periodic audit, the auditing procedure might not be invoked for the case of a received *SCON* message containing a congestion level value of "no congestion" or undefined" (i.e., congestion Level = "0"). This is because the value indicates either congestion abatement or that the ITU MTP3 international congestion method is being used. In the international congestion method, the MTP3 layer at the SGP does not maintain the congestion status of any destinations and therefore the SGP cannot provide any congestion information in response to the *DAUD*. For the same reason, in the second of the cases above a *DAUD* message cannot reveal any congested destination(s).
- [3] **IMPLEMENTATION NOTE:**– For example, an SGP **MAY** chose to not respond to a request for the destination or subsystem status of a specific point code in the *DAUD* message because the ASP that issued the *DAUD* message is not authorized to obtain information concerning the status of the destination as requested.
- [4] **IMPLEMENTATION NOTE:**– Typically a TC-User is responsible for performing the segmentation and reassembly of components.

5. Examples of TUA Procedures

5.1. Establishment of Association and Traffic between SGPs and ASPs

5.1.1.1. Single ASP in an Application Server ("1+0" sparing)

This scenario shows the example TUA message flows for the establishment of traffic between an SG and an ASP, where only one ASP is configured within an AS (no backup). It is assumed that the SCTP association is already set-up.

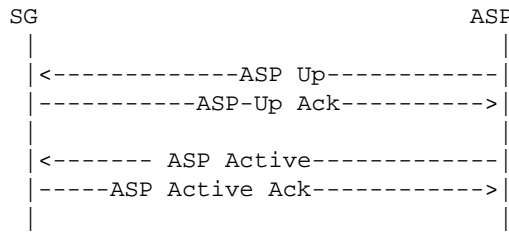

5.1.1.2. Two ASPs in Application Server ("1+1" sparing)

This scenario shows the example TUA message flows for the establishment of traffic between an SG and two ASPs in the same Application Server, where ASP1 is configured to be "active" and ASP2 a "standby" in the event of communication failure or the withdrawal from service of ASP1. ASP2 may act as a hot, warm, or cold standby depending on the extent to which ASP1 and ASP2 share call or transaction state or can communicate call state under failure or withdrawal events. The example message flow is the same whether the *ASP Active (ASPAC)* messages are Override or Load-share mode although typically this example would use an Override mode.

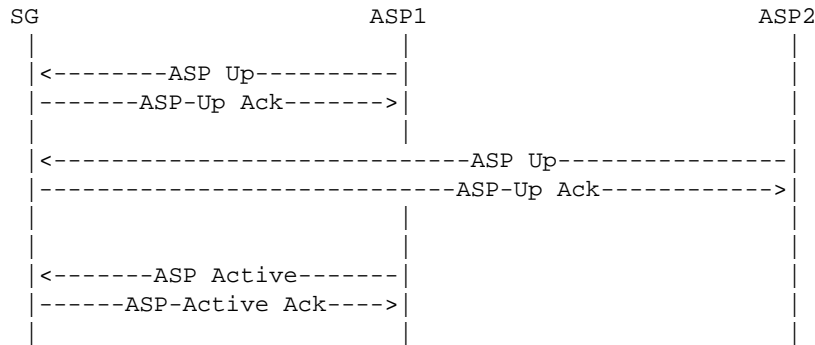

5.1.1.3. Two ASPs in an Application Server ("1+1" sparing, load-sharing case)

This scenario shows the example TUA message flows for the establishment of traffic between an SG and two ASPs in the same Application Server, where the two ASPs are brought to "active" and load-share the traffic load. In this case, one ASP is sufficient to handle the total traffic load.

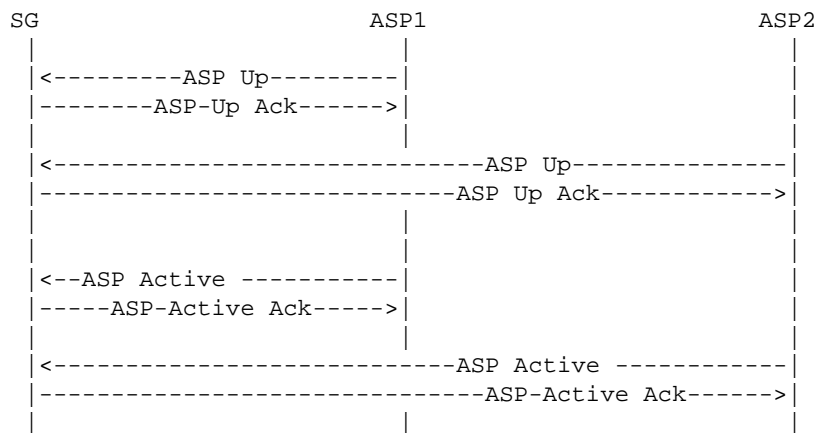

5.1.1.4. Three ASPs in an Application Server ("n+k" sparing, load-sharing case)

This scenario shows the example TUA message flows for the establishment of traffic between an SG and three ASPs in the same Application Server, where two of the ASPs are brought to "active" and share the load. In

this case, a minimum of two ASPs are required to handle the total traffic load (2+1 sparing).

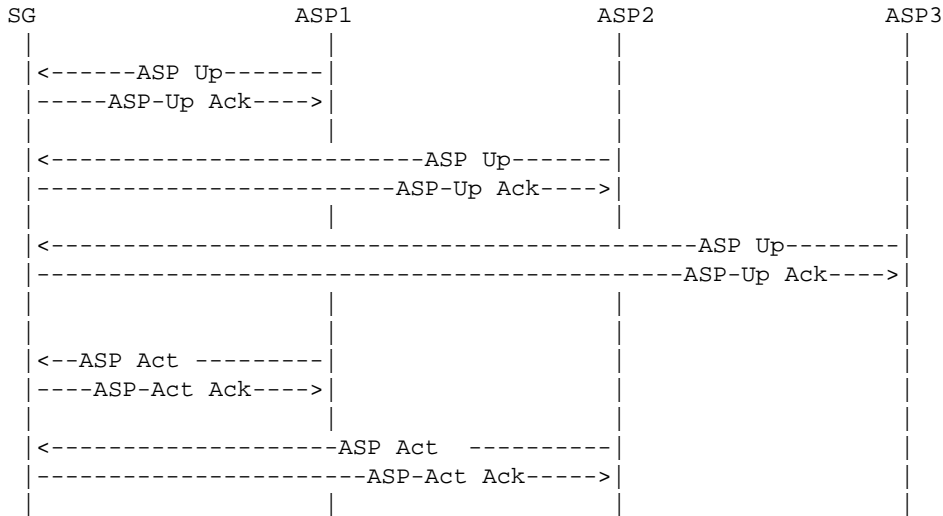

5.1.2. ASP Traffic Fail-over Examples

5.1.2.1. (1+1 Sparing, withdrawal of ASP, Back-up Override)

ASP1 withdraws from service:

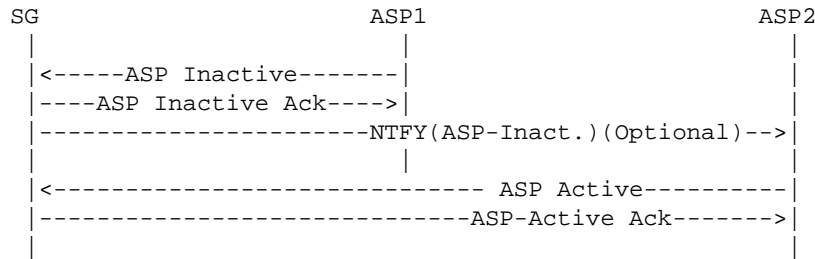

Note: If the SG detects loss of the TUA peer (TUA heartbeat loss or detection of SCTP failure), the initial SG-ASP1 *ASP Inactive (ASPIA)* message exchange would not occur.

5.1.2.2. (1+1 Sparing, Back-up Override)

ASP2 wishes to override ASP1 and take over the traffic:

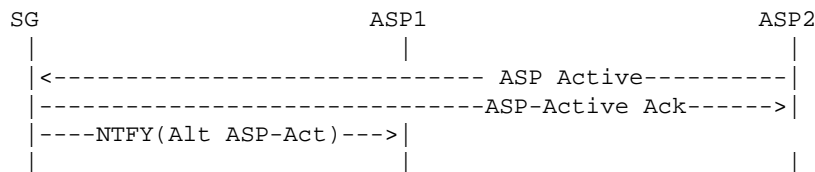

5.1.2.3. (n+k Sparing, Load-sharing case, withdrawal of ASP)

ASP1 withdraws from service:

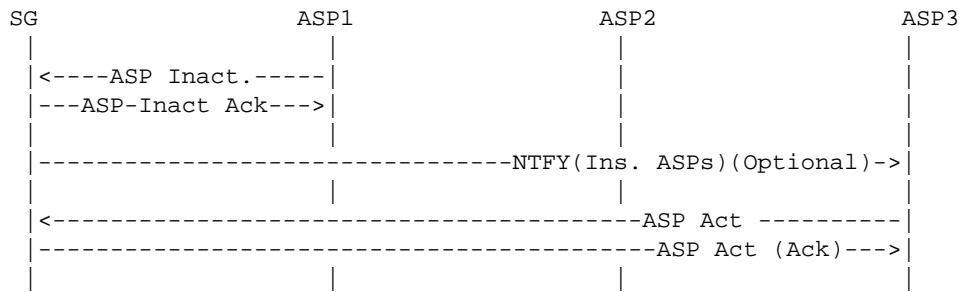

The *Notify (NTFY)* message to ASP3 is optional, as well as the ASP-Active from ASP3. The optional Notify can only occur if the SG maintains knowledge of the minimum ASP resources required - for example if the SG knows that "n+k" = "2+1" for a load-share AS and "n" currently equals "1".

Note: If the SG detects loss of the ASP1 TUA peer (TUA heartbeat loss or detection of SCTP failure), the first SG-ASP1 *ASP Inactive (ASPIA)* message exchange would not occur.

5.1.3. TCAP/TC-User Service Translation Examples

When the TUA layer on the ASP has a DH message to send to the SG, it will do the following:

- (1) Determine the correct SGP
- (2) Find the SCTP association to the chosen SGP
- (3) Determine the correct stream in the SCTP association based on the DID
- (4) Build the DH message, fill TUA Message Header, fill Common Header
- (5) Send the DH message to the remote TUA peer in the SG, over the SCTP association

When the TUA layer on the SG has a DH message to send to the ASP, it will do the following:

- (1) Determine the AS
- (2) Determine the Active ASP (SCTP association) within the AS
- (3) Determine the correct stream in the SCTP association based on the DID
- (4) Build the DH message, fill in TUA Message Header, fill in Common Header
- (5) Send the DH message to the remote TUA peer in the ASP, over the SCTP association

An example of the message flows for establishing a dialogue service is shown below. An active association between ASP and SG is established (Section 5.1) prior to the following message flows.

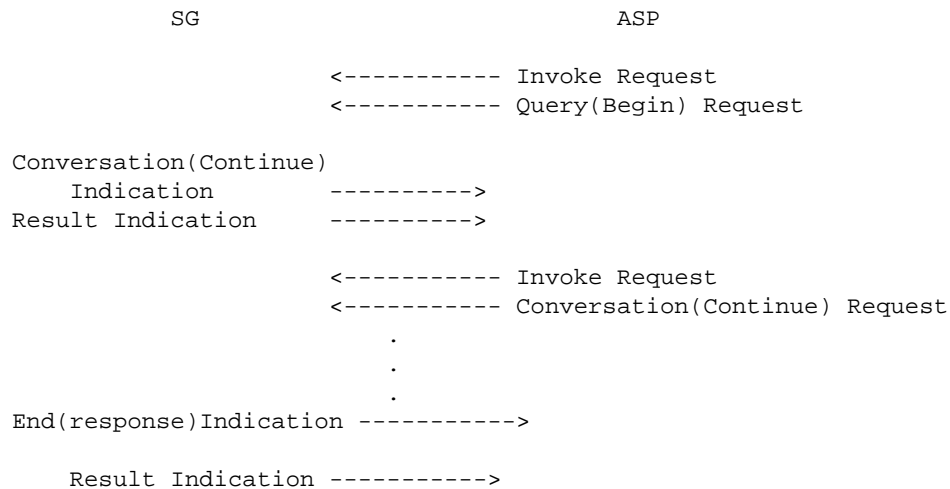

An example of the message flows for a failed attempt to establish a dialogue on the signalling channel is shown below. In this case, the gateway has a problem with its physical connection , so it cannot establish a dialogue on the signalling channel.

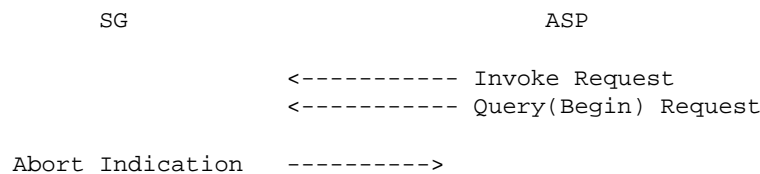

5.2. IP-IP Architecture

The sequences below outline logical steps for a variety of scenarios within an IP-IP architecture. Please note that these scenarios cover a Primary/Backup configuration. Where there is a load-sharing configuration then the AS can declare availability when 1 ASP issues ASPAC but can only declare unavailability when all ASPs have issued ASPIA.

5.2.1. Establishment of TUA connectivity

The following shows an example establishment of TUA connectivity. In this example, each IP SP consists of a Management Instance (MI) and two ASPs. The Management Instance handles the address mapping mechanisms and monitors the states of the remote peer. For simplicity, the Management Instances and ASPs are considered as a separate entity. This is not a requirement, as they can be collocated with an ASP.

The following must be established before TUA traffic can flow. A connection-less flow is shown for simplicity.

Each node is configured (via MIB, for example) with the connections that need to be setup

```

IP SEP A                               IP SEP B
ASP-a1   ASP-a2   MI a               MI b   ASP-b2   ASP-b1
(Primary) (Backup)                   (Backup) (Primary)
    
```

Establish SCTP Connectivity

```

|-- Est. SCTP Ass.--|
|----- Establish SCTP Association -----|
|----- Establish SCTP Association -----|
|----- Establish SCTP Association -----|

|--- Establish SCTP Assoc. ---|
|----- Establish SCTP Association -----|
|----- Establish SCTP Association -----|

|-- Establish SCTP Association -|
|----- Establish SCTP Association -----|
    
```

Establish TUA Connectivity

```

+-----ASP Up----->
<-----ASP Up Ack-----+

+-----ASP Up----->
<-----ASP Up Ack-----+

<-----ASP Up-----+
+-----ASP Up Ack----->

<-----ASP Up-----+
+-----ASP Up Ack----->

+-----ASP Act----->
<-----ASP Act Ack-----+

<-----ASP Act-----+
+-----ASP Act Ack----->

Traffic can now flow directly between ASPs.

+-----TCAP_User Message----->
    
```

5.2.2. Fail-over scenarios

The following sequences address fail-over of ASP

5.2.2.1. Successful ASP Fail-over scenario

The following is an example of a successful fail-over scenario, where there is a fail-over from ASP-a1 to ASP-a2, i.e, Primary to Backup. Since data transfer passes directly between peer ASPs, ASP-b1 is notified of the fail-over of ASP-a1 and must buffer outgoing data messages until ASP-a2 becomes available.

```

IP SEP A
ASP-a1      ASP-a2      MI a          MI b          ASP-b2      ASP-b1
(Primary) (Backup)
+-----ASP Inact----->
<-----ASP Inact Ack-----+

                <----NTFY (ASP-a1 Inactive)----+

                +-----ASP Act----->
                <-----ASP Act Ack-----+

```

5.2.2.2. Unsuccessful ASP Fail-over scenario

The sequence is the same as 5.2.2.1 except that, since the backup fails to come in then, the *Notify (NTFY)* messages declaring the availability of the backup are not sent.

6. Security Considerations

The security considerations discussed for the “*Security Considerations for SIGTRAN Protocols*” document [SIGSEC] apply to this document.

7. IANA Considerations

7.1. SCTP Payload Protocol ID

IANA has assigned a TUA value for the Payload Protocol Identifier in the SCTP DATA chunk. The following SCTP Payload Protocol Identifier is registered:

TUA "5"

The SCTP Payload Protocol Identifier value "5" **SHOULD** be included in each SCTP DATA chunk, to indicate that the SCTP is carrying the TUA protocol. The value "0" (unspecified) is also allowed but any other values **MUST NOT** be used. This Payload Protocol Identifier is not directly used by SCTP but **MAY** be used by certain network entities to identify the type of information being carried in a DATA chunk.

EDITOR'S NOTE:– The value shown above as "5" is to be assigned by IANA and may change in future versions of this document.

The User Adaptation peer **MAY** use the Payload Protocol Identifier, as a way of determining additional information about the data being presented to it by SCTP. A request will be made to IANA to assign CTP Payload Protocol IDs.

7.2. Port Number

IANA has registered SCTP Port Number 14001 for TUA. It is recommended that SGPs use this SCTP port number for listening for new connections. SGPs **MAY** also use statically configured SCTP port numbers instead.

7.3. Protocol Extensions

This protocol may also be extended through IANA in three ways:

- Through definition of additional message classes.
- Through definition of additional message types.
- Through definition of additional message parameters.

The definition and use of new message classes, types and parameters is an integral part of SIGTRAN adaptation layers. Thus, these extensions are assigned by IANA through an IETF Consensus action as defined in [RFC 2434].

The proposed extension **MUST** in no way adversely affect the general working of the protocol.

A new registry will be created by IANA to allow

7.3.1. IETF Defined Message Classes

The documentation for a new message class **MUST** include the following information:

- (1) A long and short name for the message class;
- (2) A detailed description of the purpose of the message class.

7.3.2. IETF Defined Message Types

Documentation of the message type **MUST** contain the following information:

- (1) A long and short name for the new message type;
- (2) A detailed description of the structure of the message.
- (3) A detailed definition and description of intended use of each field within the message.
- (4) A detailed procedural description of the use of the new message type within the operation of the protocol.
- (5) A detailed description of error conditions when receiving this message type.

When an implementation receives a message type which it does not support, it **MUST** respond with an Error (ERR) message, with an Error Code = Unsupported Message Type.

7.3.3. IETF-defined TLV Parameter Extension

Documentation of the message parameter **MUST** contain the following information:

- (1) Name of the parameter type.
- (2) Detailed description of the structure of the parameter field. This structure **MUST** conform to the general type-length-value format described earlier in the document.
- (3) Detailed definition of each component of the parameter value.
- (4) Detailed description of the intended use of this parameter type, and an indication of whether and under what circumstances multiple instances of this parameter type may be found within the same message type.

8. Timer Values

Following are the **RECOMMENDED** timer values for TUA timers:

Timer	Description	Value
Ta	–	2 seconds
Tr	–	2 seconds
T(ack)	Inactivity Send Timer	7 minutes
T(ias)	Inactivity Receive Timer	15 minutes
T(beat)	Heartbeat Timer	30 seconds

Appendices

A. Operational Considerations

A.1. Signalling Network Architecture

A Signalling Gateway is used to support the transport of TC-User signalling traffic received from the SS7 network to multiple distributed ASPs (e.g., MGCs and IP Databases). Clearly, the TUA protocol is not designed to meet the performance and reliability requirements for such transport by itself. However, the conjunction of distributed architecture and redundant networks provides support for reliable transport of signalling traffic over IP. The TUA protocol is flexible enough to allow its operation and management in a variety of physical configurations, enabling Network Operators to meet their performance and reliability requirements.

To meet the stringent SS7 signalling reliability and performance requirements for carrier grade networks, Network Operators might require that no single point of failure is present in the end-to-end network architecture between an SS7 node and an IP-based application. This can typically be achieved through the use of redundant SGPs or SGs, redundant hosts, and the provision of redundant QOS-bounded IP network paths for SCTP Associations between SCTP End Points. Obviously, the reliability of the SG, the MGC and other IP-based functional elements also needs to be taken into account. The distribution of ASPs and SGPs within the available Hosts MAY also be considered. As an example, for a particular Application Server, the related ASPs could be distributed over at least two Hosts.

One example of a physical network architecture relevant to SS7 carrier-grade operation in the IP network domain is shown in *Figure 7*.

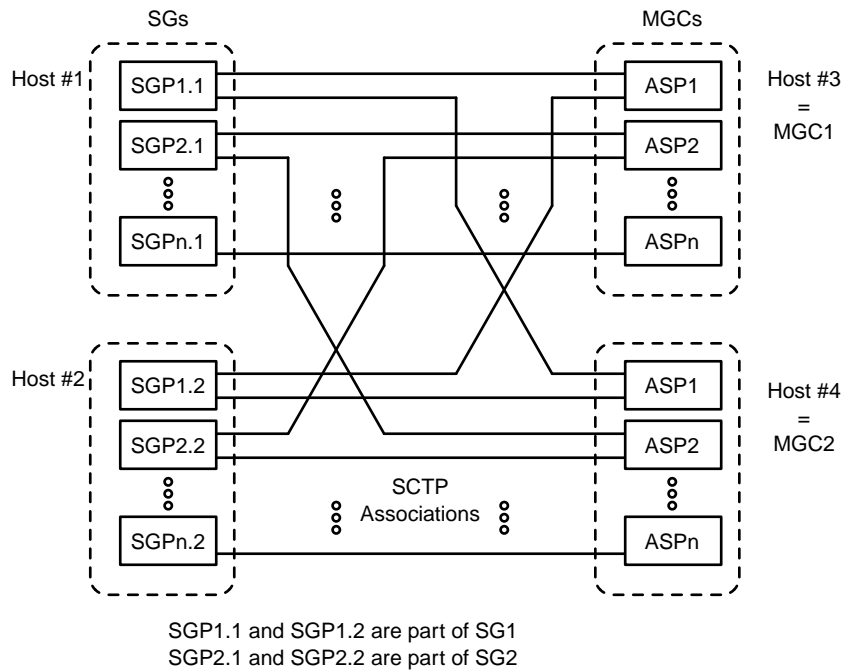

Figure 7. Physical Model

In this model, each host MAY have many application processes. In the case of the MGC, an ASP may provide service to one or more Application Servers, and is identified as an SCTP end point. One or more Signalling Gateway Processes make up a single Signalling Gateway.

This example model can also be applied to IPSP-IPSP signalling. In this case, each IPSP MAY have its services distributed across 2 hosts or more, and may have multiple server processes on each host.

In the example above, each signalling process (SGP, ASP or IPSP) is the end point to more than one SCTP association, leading to more than one other signalling processes. To support this, a signalling process must be able to support distribution of TUA messages to many simultaneous active associations. This message distribution function is based on the status of provisioned Routing Keys, the status of the signalling routes to signalling points in the SS7 network, and the redundancy model (override, load-sharing, broadcast) of the remote signalling processes.

For carrier grade networks, the failure or isolation of a particular signalling process should not cause transactions to be lost. This implies that signalling processes need, in some cases, to share the transaction state or be able to pass the transaction state information between each other. However, this sharing or communication of transaction state information is outside the scope of this document.

This model serves as an example. TUA imposes no restrictions as to the exact layout of the network elements, the message distribution algorithms and the distribution of the signalling processes. Instead, it provides a framework and a set of messages that allow for a flexible and scalable signalling network architecture, aiming to provide reliability and performance.

A.2. Redundancy Models

A.2.1. Application Server Redundancy

At the SGP, an Application Server list contains active and inactive ASPs to support ASP broadcast, load-sharing and override procedures. The list of ASPs within a logical Application Server is kept updated in the SGP to reflect the active Application Server Processes.

For example, in the network shown in *Figure 7*, all messages to SSN x could be sent to ASP1 in Host3 or ASP1 in Host4. The AS list at SGP1 in Host 1 might look like the following:

```
Routing Key {SSN=x) - "Application Server #1"  
  ASP1/Host3      - State = Active  
  ASP1/Host4      - State = Inactive
```

In this "1+1" redundancy case, ASP1 in Host3 would be sent any incoming message with SSN=x. ASP1 in Host4 would normally be brought to the "active" state upon failure of, or loss of connectivity to, ASP1/Host1.

The AS List at SGP1 in Host1 might also be set up in load-share mode:

```
Routing Key {SSN=x) - "Application Server #1"  
  ASP1/Host3      - State = Active  
  ASP1/Host4      - State = Active
```

In this case, both the ASPs would be sent a portion of the traffic. For example the two ASPs could together form a database, where incoming queries may be sent to any active ASP.

Care might need to be exercised by a Network Operator in the selection of the routing information to be used as the Routing Key for a particular AS.

For example, where Application Servers are defined using ranges of GT Address values, the Operator is implicitly splitting up control of the related address groups. Some GT address value range assignments may interfere with TCAP subsystem management procedures.

In the process of fail-over, it is recommended that in the case of ASPs that transactions do not fail. For example, the two ASPs may share transaction state via shared memory, or may use an ASP to ASP protocol to pass transaction state information. Any ASP-to-ASP protocol to support this function is outside the scope of this document.

A.2.2. Signalling Gateway Redundancy

Signalling Gateways may also be distributed over multiple hosts. Much like the AS model, SGs may comprise one or more SG Processes (SGPs), distributed over one or more hosts, using an override, load-share or broadcast model. Should an SGP lose all or partial SS7 connectivity and other SGPs exist, the SGP may terminate the SCTP associations to the concerned ASPs or send an unsolicited ASPIA ACK for the concerned Application Servers.

It is possible for an ASP to route signalling messages destined to the SS7 network using more than one SGP. In this model, a Signalling Gateway is deployed as a cluster of hosts acting as a single SG. An override redundancy model is possible, where the unavailability of the SCTP association to a primary SGP could be used to reroute affected traffic to an alternate SGP. A load-sharing model is possible, where the signalling messages are load-shared between multiple SGPs. A broadcast model is also possible, where signalling messages are sent to

each active SGP in the SG. The distribution of the TC-user messages over the SGPs should be done in such a way to minimize message mis-sequencing, as required by the SS7 User Parts.

It may also be possible for an ASP to use more than one SG to access a specific SS7 end point, in a model that resembles an SS7 STP mated pair. Typically, SS7 STPs are deployed in mated pairs, with traffic load-shared between them. Other models are also possible, subject to the limitations of the local SS7 network provisioning guidelines.

From the perspective of the TUA layer at an ASP, a particular SG is capable of transferring traffic to a provisioned SS7 destination, subsystem or application X if an SCTP association with at least one SGP of the SG is established, the SGP has returned an acknowledgment to the ASP to indicate that the ASP is actively handling traffic for that destination, subsystem or application X, and the SGP has not indicated that the destination, subsystem or application X is inaccessible. When an ASP is configured to use multiple SGPs for transferring traffic to the SS7 network, the ASP must maintain knowledge of the current capability of the SGPs to handle traffic to destinations, subsystems and applications of interest. This information is crucial to the overall reliability of the service, for override, load-sharing and broadcast models, in the event of failures, recovery and maintenance activities. The ASP TUA may also use this information for congestion avoidance purposes. The distribution of the TC-user messages over the SGPs should be done in such a way to minimize message mis-sequencing, as required by the some TCAP applications.

0. Change History

This section provides historical information on the changes made to this draft. This section will be removed from the document when the document is finalized.

0.4. Changes from Version 0.3 to Version 0.4

- changed to new boilerplate for first and last page
- updated references and version numbers

0.3. Changes from Version 0.2 to Version 0.3

- updated references and version numbers

0.2. Changes from Version 0.1 to Version 0.2

- split references into Normative and Informative sections.
- updated security section.
- updated references and version numbers.
- split abbreviations and terminology.
- moved appendices.
- minor formatting changes.

0.1. Changes from Version 0.0 to Version 0.1

- updated security, references and version numbers,
- updated registration procedures to be consistent with M3UA [M3UA] and SUA [SUA],
- updated author's address.

Change Log

```
$Log: draft-bidulock-sigtran-tua-04.me,v $
Revision 0.9.2.3  2005/10/17 11:53:44  brian
- updated drafts for republication

Revision 0.9.2.2  2005/05/14 08:33:17  brian
- copyright header correction

Revision 0.9.2.1  2004/03/16 05:10:28  brian
- Added drafts and figures.

Revision 0.8.2.5  2003/07/29 00:34:57  brian
Finalizing latest round of drafts.

Revision 0.8.2.4  2003/07/28 13:12:48  brian
Reformatting.
```

R. References

R.1. Normative References

- [RFC 2119] Bradner, S., “*Key words for use in RFCs to Indicate Requirement Levels*,” **RFC 2119 - BCP 14**, The Internet Society (March 1997).
- [RFC 2960] Stewart, R., Xie, Q., Morneault, K., Sharp, C., Schwarzbauer, H. J., Taylor, T., Rytina, I., Kalla, H., Zhang, L. and Paxson, V., “*Stream Control Transmission Protocol (SCTP)*,” **RFC 2960**, The Internet Society (February 2000).
- [RFC 2279] Yergenau, F., “*UTF-8, a transformation format of ISO 10646*,” **RFC 2279**, Internet Engineering Task Force (January 1998).
- [X.680] ITU, “*Abstract Syntax Notation One (ASN.1): Specification of Basic Notation*,” **ITU-T Recommendation X.680**, ITU-T Telecommunication Standardization Sector of ITU, Geneva (July 1994). (*Previously "CCITT Recommendation"*)
- [SIGSEC] Loughney, J., Tuexen, M. and Pastor-Balbas, J., “*Security Considerations for Signaling Transport (SIGTRAN) Protocols*,” **RFC 3788**, Internet Engineering Task Force - Signalling Transport Working Group (June 2004).
- [RFC 2434] Narten, T., Alvestrand, H. T., “*Guidelines for Writing an IANA Considerations Section in RFCs*,” **RFC 2434**, The Internet Society (October, 1998).

R.2. Informative References

- [RFC 2719] Ong, L., Rytina, I., Holdrege, M., Coene, L., Garcia, M.-A., Sharp, C., Juhasz, I., Lin, H. P. and Schwarzbauer, HannsJ., “*Framework Architecture for Signaling Transport*,” **RFC 2719**, The Internet Society (October, 1999).
- [Q.771] ITU, “*Signalling System No. 7 – Functional Description of Transaction Capabilities*,” **ITU-T Recommendation Q.771**, ITU-T Telecommunication Standardization Sector of ITU, Geneva (March 1993). (*Previously "CCITT Recommendation"*)
- [T1.114] ANSI, “*Signalling System No. 7 – Transaction Capabilities Application Part*,” **ANSI T1.114**, American National Standards Institute (1992).
- [Q.701] ITU, “*Functional Description of the Message Transfer Part (MTP) of Signalling System No. 7*,” **ITU-T Recommendation Q.701**, ITU-T Telecommunication Standardization Sector of ITU, Geneva (March 1993). (*Previously "CCITT Recommendation"*)
- [T1.111] ANSI, “*Signalling System No. 7 – Message Transfer Part*,” **ANSI T1.111**, American National Standards Institute (1992).
- [Q.711] ITU, “*Functional Description of Signalling Connection Control Part*,” **ITU-T Recommendation Q.711**, ITU-T Telecommunication Standardization Sector of ITU, Geneva (March 1993). (*Previously "CCITT Recommendation"*)
- [RFC 2916] Falstrom, P., “*E.164 number and DNS (ENUM)*,” **RFC 2916**, The Internet Society (September 2000).

- [**Q.704**] ITU, “*Message Transfer Part – Signalling Network Functions and Messages*,” **ITU-T Recommendation Q.704**, ITU-T Telecommunication Standardization Sector of ITU, Geneva (March 1993). (*Previously "CCITT Recommendation"*)
- [**SUA**] Loughney, J., Sidebottom, G., Coene, L., Verwimp, G., Keller, J. and Bidulock, B., “*Signalling Connection Control Part User Adaptation Layer (SUA)*,” **RFC 3868**, Internet Engineering Task Force - Signalling Transport Working Group (October, 2004).
- [**M3UA**] Sidebottom, G., Morneault, K. and Pastor-Balbas, J., (eds), “*Signaling System 7 (SS7) Message Transfer Part 3 (MTP3) - User Adaptation Layer (M3UA)*,” **RFC 3332**, Internet Engineering Task Force - Signalling Transport Working Group (September, 2002).
- [**Q.705**] ITU, “*Signalling System No. 7 – Signalling Network Structure*,” **ITU-T Recommendation Q.705**, ITU-T Telecommunication Standardization Sector of ITU, Geneva (March 1993). (*Previously "CCITT Recommendation"*)
- [**T1.112**] ANSI, “*Signalling System No. 7 – Signalling Connection Control Part*,” **ANSI T1.112**, American National Standards Institute (1992).
- [**Q.773**] ITU, “*Signalling System No. 7 – Transaction Capabilities Formats and Encoding*,” **ITU-T Recommendation Q.773**, ITU-T Telecommunication Standardization Sector of ITU, Geneva (March 1993). (*Previously "CCITT Recommendation"*)
- [**Q.775**] ITU, “*Signalling System No. 7 – Guidelines for Using Transaction Capabilities*,” **ITU-T Recommendation Q.775**, ITU-T Telecommunication Standardization Sector of ITU, Geneva (March 1993). (*Previously "CCITT Recommendation"*)
- [**CORID**] Bidulock, B., “*Correlation Id and Heartbeat Procedures Supporting Lossless Fail-Over*,” <**draft-bidulock-sigtran-corid-03.txt**>, Internet Engineering Task Force - Signalling Transport Working Group (February 24, 2004). *Work In Progress*.
- [**Q.714**] ITU, “*Signalling Connection Control Part Procedures*,” **ITU-T Recommendation Q.714**, ITU-T Telecommunication Standardization Sector of ITU, Geneva (March 1993). (*Previously "CCITT Recommendation"*)
- [**Q.713**] ITU, “*Signalling Connection Control Part Formats and Codes*,” **ITU-T Recommendation Q.713**, ITU-T Telecommunication Standardization Sector of ITU, Geneva (March 1993). (*Previously "CCITT Recommendation"*)

Acknowledgments

The authors would like to thank Jianxing Hou, Min Lin for their original input to this document, and to the authors of M2UA, M3UA and SUA for the large sections of text which apply also to TUA and was included here.

Author's Addresses

Brian Bidulock
OpenSS7 Corporation
1469 Jeffreys Crescent
Edmonton, AB T6L 6T1
Canada

Phone: +1-780-490-1141
Email: bidulock@openss7.org
URL: <http://www.openss7.org/>

This draft expires April 2006.

List of Tables

Table 1. Mapping of Management Primitives	6
Table 2. Mapping of Dialogue Handling Primitives	11
Table 3. Mapping of Component Handling Primitives	12

List of Illustrations

Figure 1. Protocol Architecture	4
Figure 2. All IP Architecture	5
Figure 3. TUA Protocol Boundaries	10
Figure 4. TUA Layer Model	92
Figure 5. ASP State Transition Diagram (Per AS)	96
Figure 6. AS State Transition Diagram	97
Figure 7. Physical Model	117

Table of Contents

Status of this Memo	1
Copyright	1
Abstract	1
Contents	1
1 Introduction	1
1.1 Scope	1
1.2 Terminology and Abbreviations	2
1.2.1 Abbreviations	2
1.2.2 Terminology	2
1.3 TUA Overview	4
1.3.1 Signalling Transport Architecture	4
1.3.2 Protocol Architecture for Classes 1, 2, 3 and 4	4
1.3.3 All IP Architecture	5
1.3.4 ASP Fail-over Model and Terminology	5
1.3.5 Services Provided by the TUA Layer	5
1.4 Functional Areas	7
1.4.1 Dialogue Identifiers, Routing Contexts and Routing Keys	7
1.4.2 Routing Key Limitations	7
1.4.3 Managing Routing Context and Routing Keys	7
1.4.4 Transaction Mapping Function	8
1.4.5 Signalling Gateway SS7 Layers	9
1.4.6 SS7 and TUA Interworking at the SG	9
1.4.7 Application Server	9
1.4.8 SCTP Stream Mapping	9
1.4.9 Application Server Redundancy	10
1.4.10 Flow Control	10
1.4.11 Congestion Management	10

1.5 Definition of TUA Boundaries	10
1.5.1 Definition of Upper Boundary	11
1.5.2 Definition of Boundary between TUA and Layer Management	12
1.5.3 Definition of the Lower Boundary	15
Notes for §1	16
2 Conventions	16
3 Protocol Elements	16
3.1 Common Message Header	16
3.1.1 TUA Protocol Version	17
3.1.2 Message Classes	17
3.1.3 Message Types	17
3.1.4 Message Length	19
3.1.5 Tag-Length-Value Format	19
3.2 TUA Message Header	20
3.3 TUA Dialogue Handling (DH) Messages	21
3.3.1 DH Message Header	21
3.3.2 Unidirectional (TUNI)	21
3.3.3 Query (TQRY)	23
3.3.4 Conversation (TCNV)	25
3.3.5 Response (TRSP)	27
3.3.6 U-Abort (TUAB)	29
3.3.7 P-Abort (TPAB)	30
3.3.8 Notice (TNOT)	30
3.4 TUA Component Handling (CH) Messages	31
3.4.1 CH Message Header	31
3.4.2 Invoke (CINV)	31
3.4.3 Result (CRES)	32
3.4.4 Error (CERR)	33
3.4.5 Reject (CREJ)	34
3.4.6 Cancel (CCAN)	34
3.5 SS7 Signalling Network Management (SSNM) Messages	34
3.5.1 Destination Unavailable (DUNA)	34
3.5.2 Destination Available (DAVA)	36
3.5.3 Destination State Audit (DAUD)	37
3.5.4 Network Congestion (SCON)	38
3.5.5 Destination User Part Unavailable (DUPU)	39
3.5.6 Destination Restricted (DRST)	40
3.6 Application Server Process State Maintenance (ASPSM) Messages	41
3.6.1 ASP Up (UP)	41
3.6.2 ASP Up Ack (UP ACK)	42
3.6.3 ASP Down (DOWN)	42
3.6.4 ASP Down Ack (DOWN ACK)	43
3.6.5 Heartbeat (BEAT)	43
3.6.6 Heartbeat Ack (BEAT ACK)	43
3.7 Application Server Process Traffic Maintenance (ASPTM) Messages	44

3.7.1 ASP Active (ASPAC)	44
3.7.2 ASP Active Ack (ASPAC ACK)	45
3.7.3 ASP Inactive (ASPIA)	45
3.7.4 ASP Inactive Ack (ASPIA ACK)	46
3.8 Management (MGMT) Messages	47
3.8.1 Error (ERR)	47
3.8.2 Notify (NTFY)	48
3.9 Routing Key Management (RKM) Messages	49
3.9.1 Registration Request (REG REQ)	49
3.9.2 Registration Response (REG RSP)	50
3.9.3 Deregistration Request (DEREG REQ)	50
3.9.4 Deregistration Response (DEREG RSP)	51
3.10 Common Parameters	52
3.10.1 Info String	52
3.10.2 Routing Context	53
3.10.3 Diagnostic Information	53
3.10.4 Heartbeat Data	54
3.10.5 Traffic Mode Type	54
3.10.6 Error Code	55
3.10.7 Status	57
3.10.8 ASP Identifier	58
3.10.9 Affected Point Code	59
3.10.10 Correlation Id	60
3.10.11 Registration Result	60
3.10.12 Deregistration Result	61
3.10.13 Registration Status	62
3.10.14 Deregistration Status	62
3.10.15 Local Routing Key Identifier	63
3.11 TUA-Specific parameters	63
3.11.1 Parameters used in DH Messages	64
3.11.2 Parameters used in CH Messages	76
3.11.3 Other Parameters	82
Notes for §3	91
4 Procedures	91
4.1 Procedures to Support the TC-User	92
4.1.1 Receipt of Primitives from the TC-User	92
4.1.2 Receipt of Primitives from TCAP	92
4.1.3 Receipt of Primitive from the Layer Management	93
4.2 Procedures to Support the Management of SCTP Associations	94
4.2.1 Receipt of TUA Peer Management Messages	94
4.3 AS and ASP State Maintenance	95
4.3.1 ASP/IPSP States	95
4.3.2 AS States	96
4.3.3 TUA Management Procedures for Primitives	98
4.3.4 ASPM Procedures for Peer-to-Peer Messages	98

4.4 Routing Key Management Procedures	104
4.4.1 Registration	104
4.4.2 Deregistration	105
4.4.3 IPSP Considerations (REG/DEREG)	106
4.5 Procedures to Support Point Code and Subsystem State	106
4.5.1 At an SGP	106
4.5.2 At an ASP	106
4.5.3 ASP Auditing	107
4.5.4 TCAP – TUA Interworking at the SG	107
Notes for §4	108
5 Examples of TUA Procedures	108
5.1 Establishment of Association and Traffic between SGPs and ASPs	108
5.1.2 ASP Traffic Fail-over Examples	110
5.1.3 TCAP/TC-User Service Translation Examples	111
5.2 IP-IP Architecture	112
5.2.1 Establishment of TUA connectivity	112
5.2.2 Fail-over scenarios	113
6 Security Considerations	114
7 IANA Considerations	114
7.1 SCTP Payload Protocol ID	114
7.2 Port Number	114
7.3 Protocol Extensions	114
7.3.1 IETF Defined Message Classes	115
7.3.2 IETF Defined Message Types	115
7.3.3 IETF-defined TLV Parameter Extension	115
8 Timer Values	115
Appendices	116
A Operational Considerations	116
A.1 Signalling Network Architecture	116
A.2 Redundancy Models	117
A.2.1 Application Server Redundancy	118
A.2.2 Signalling Gateway Redundancy	118
0 Change History	120
0.4 Changes from Version 0.3 to Version 0.4	120
0.3 Changes from Version 0.2 to Version 0.3	120
0.2 Changes from Version 0.1 to Version 0.2	120
0.1 Changes from Version 0.0 to Version 0.1	120
Change Log	120
R References	121
R.1 Normative References	121
R.2 Informative References	121
Acknowledgments	123
Author's Addresses	123
List of Tables	124
List of Illustrations	124

Table of Contents 124

Intellectual Property

The IETF takes no position regarding the validity or scope of any Intellectual Property Rights or other rights that might be claimed to pertain to the implementation or use of the technology described in this document or the extent to which any license under such rights might or might not be available; nor does it represent that it has made any independent effort to identify such rights. Information on the procedures with respect to rights in RFC documents can be found in BCP 78 and BCP 79.

Copies of IPR disclosures made to the IETF Secretariat and any assurances of licenses to be made available, or the result of an attempt made to obtain general license or permission for the use of such proprietary rights by implementers or users of this specification can be obtained from the IETF on-line IPR repository at <http://www.ietf.org/ipr>.

The IETF invites any interested party to bring to its attention any copyrights, patents or patent applications, or other proprietary rights that may cover technology that may be required to implement this standard. Please address to the IETF at ietf-ipr@ietf.org.

Disclaimer of Validity

This document and the information contained herein is provided on an "AS IS" basis and **THE CONTRIBUTOR, THE ORGANIZATION HE/SHE REPRESENTS OR IS SPONSORED BY (IF ANY), THE INTERNET SOCIETY AND THE INTERNET ENGINEERING TASK FORCE DISCLAIMS ALL WARRANTIES, EXPRESS OR IMPLIED, INCLUDING BUT NOT LIMITED TO ANY WARRANTY THAT THE USE OF THE INFORMATION HEREIN WILL NOT INFRINGE ANY RIGHTS OR ANY IMPLIED WARRANTIES OF MERCHANTABILITY OR FITNESS FOR A PARTICULAR PURPOSE.**

Full Copyright Statement

Copyright © The Internet Society (2005). This document is subject to the rights, licenses and restrictions contained in BCP 78, and except as set forth therein, the authors retain all their rights.

Acknowledgement

Funding for the RFC Editor function is currently provided by the Internet Society.